



Operations & Maintenance Manual for the EXO Original and EXO Balanced Regulator Full Face Mask

**Product discontinued from CE market since 2017:
this manual is presented in its original form.**

Part #: 100-030

Kirby Morgan Dive Systems, Inc.

1430 Jason Way

Santa Maria, CA 93455, USA

Telephone (805) 928-7772

FAX (805) 928-0342

E-Mail: KMDSI@KirbyMorgan.com

Web Site: www.KirbyMorgan.com

Kirby Morgan, SuperLite, BandMask, Band Mask, KMB, KMB-Band Mask, DSI, Diving Systems International, EXO, REX, SuperFlow and DECA are all registered trademarks of Kirby Morgan Dive Systems, Inc. **Use of these terms to describe products that are not manufactured by KMDSI is illegal.**

© MMXXI Kirby Morgan Dive Systems, Inc. All rights reserved. This manual is made available for the express use of owner of this Kirby Morgan product. No part of this manual may be reproduced, stored in any retrieval system, or transmitted, or used in any form or by any means, whether graphic, electronic, mechanical, photocopy, or otherwise by technology known or unknown, without the prior written permission of Kirby Morgan Dive Systems, Inc.



CAUTION

KMDSI must have your current address to ensure that you receive all safety notices and other important information concerning the mask. Please notify KMDSI of any change of address.

Record Of Changes

It is the responsibility of the owner of this product to register their ownership with Kirby Morgan Dive Systems, Inc., by sending the warranty card provided. This card is to establish registration for any necessary warranty work and as a means of communication that allows KMDSI to contact the user regarding this product. The user must notify KMDSI of any change of address by the user or sale of the product.

All changes or revisions to this manual must be recorded in this document to ensure that the manual is up to date.

Change Number	Date	Description of Change
1	4/07	Changed warning format. Added chapter on general maintenance and sanitation. Renamed photos. Layout in Adobe InDesign. Added additional warning on use in petroleum environments, and avoidance of use of chemical thread lockers.
2	1/08	Added new information on compressor supply pressures for low-pressure systems.
3	7/08	New photographs of EXO-BR. Updated drawings
4	11/08	Changed regulator adjustment procedure. New pressure range for EXO regulators specified 135-150 p.s.i.g. Added recommendation for locking sleeve quick disconnect fitting. Regulator mount nut should be tightened to 100 inch pounds.
5	03/20/2009	Table of contents redesign.
6	03/24/2010	Updated chapter 1 and copyright.
7	01/21/2011	Updated warranty information and table of equivalents
8	04/06/2011	Updated earphones throughout manual
9	03/22/2012	Added CE certification info
10	06/13/2012	Update copyright date to roman numerals
11	04/18/2013	Updated overpressure relief valve torque specs, verbiage and "head protector" to "hard shell"
12	11/08/2021	Added, "Product discontinued from CE market since 2017: this manual is presented in its original form" to the front page.

Table Of Contents

Record Of Changes	III
About this Manual	VII
Definitions of Signal Words Used in this Manual	VII
Warranty Information	X
Chapter 1 General Information KMDSI Products	1
1.1 Introduction	1
1.2 Full-Face Masks and Manifolds	2
1.3 Kirby Morgan Diving Helmets	4
Chapter 2 Operating Instructions	9
2.1 Introduction	9
2.2 First Use and Pre-Dive Set-Up	9
2.3 Pre Dress-in Procedure	9
2.4 Visual Inspection	9
2.5 Clean Face Port	9
2.6 Adjusting the Equalizer EXO Standard or BR	10
2.7 Checking Regulator Functions & Preparing the EXO for Use In SCUBA Mode	11
2.8 Test the Regulator	12
2.9 Wireless Communications	12
2.10 Using the EXO in the Surface-Supplied Mode	13
2.11 Testing the Manifold Block	14
2.11.1 Testing the One-Way Valve	14
2.11.2 Testing the Emergency Valve	14
2.12 Diver's Harness	15
2.13 Installing the Manifold Block on the Diver's Harness	15
2.14 Bail-Out Bottle (Emergency Air Supply)	16
2.15 First Stage Regulator	16
2.16 Over-Pressure Relief Valve	17
2.17 Configuring Your Emergency Gas System	18
2.18 Connecting the Hoses to the Manifold Block	20
2.19 Use of Quick-Disconnect	20
2.20 Connecting the Umbilical to the Mask	21
2.21 Opening the Breathing Gas Supply to the Mask	22
2.22 Fogging Prevention	22
2.23 Proper Hood Fit	23
2.24 Recommendations for Donning and Removing	24
2.25 Donning the EXO Mask	25
2.26 Removal of the EXO Mask	26
Chapter 3 Diving With The EXO Full-Face Mask	27
3.1 Introduction	27
3.2 Water Entry	27
3.3 Regulator Adjustment	27
3.4 Spider Adjustment	28
3.5 Purging the Mask	28

3.6 Procedures to Follow for Loss of Breathing Gas	29
Chapter 4 Post Dive Procedures And General Maintenance	31
4.1 Introduction	31
4.2 Required tools, Sealing, Cleaning Agents, Lubrication	31
4.3 Component and Parts Cleaning	31
4.3.1 Component and Parts Lubrication	31
4.4 Disconnecting the Mask from the Diving System	32
4.5 Daily Maintenance	33
4.6 Inspection Procedures	34
4.7 General Cleaning Guidelines	36
4.7.1 Mild Soap Solution for General Cleaning and Leak Detector Use	36
4.7.2 Acidic Cleaning Solution and Procedures	36
4.7.3 Germicidal Cleaning Solutions and Procedure	36
4.8 Communications Inspection	38
4.9 Reassembling the Mask After Cleaning	38
Chapter 5 EXO Regulator Maintenance	39
5.1 General Information	39
5.1.1 Special Regulator Tools	39
5.2 Original and Standard EXO Regulator Disassembly	40
5.3 Original and Standard EXO Rebuild	43
5.4 EXO Balanced Regulator Disassembly	44
5.5 EXO-BR Regulator Reassembly	47
5.6 Regulator Assembly Removal and Installation	50
5.6.1 Regulator Assembly Removal	50
5.6.2 Regulator Assembly Installation	52
5.7 EXO Regulator Adjustment	54
5.8 Manifold Block Maintenance	56
5.8.1 Daily Maintenance	56
5.8.2 Post Dive Procedures	56
5.8.3 Annual Overhaul of the Manifold Block Assembly	56
5.8.3.1 Disassembly Of Manifold Block	56
5.8.3.2 Disassembly and Cleaning of the One Way Valve	57
5.8.3.3 Reassembly of the One Way Valve	57
5.8.3.4 Disassembly of the Emergency Gas Supply Valve	59
5.8.3.5 Cleaning and Lubricating the Emergency Gas Supply Valve	59
5.8.3.6 Reassembly of Emergency Gas Supply Valve	59
5.9 Overpressure Relief Valve (P/N 200-017) Overhaul Procedures	61
5.9.1 Overpressure Relief Valve General	61
5.9.2 Overpressure Relief Valve Disassembly and Cleaning	61
5.9.3 Overpressure Relief Valve Reassembly	62
5.9.4 Overpressure Relief Valve Lift Check/Setting	62
Chapter 6 Frame And Lens Repairs	65
6.1 General Information	65
6.2 Lens Replacement	65
6.2.1 Lens Removal	65
6.2.2 Lens Installation	66
6.3 Buckle Replacement	70

6.3.1 Buckle Removal	70
6.3.2 Buckle Installation	70
6.4 Replacing the Face Seal or Frame	72
6.4.1 Face Seal Removal	72
6.4.2 Face Seal Installation	72
Chapter 7 Communications	73
7.1 Bare Wire Binding Posts	73
7.2 Waterproof Connector (WPC)	73
7.3 Wireless Communications	75
7.4 Removing the Communications Module	76
7.5 Installing the Communications Module	77
7.6 Earphone and/or Microphone Removal	78
7.7 Earphone and/or Microphone Installation	78
7.8 Removing the Waterproof Connector (WPC)	79
7.9 Installing the Waterproof Connector (WPC)	79
7.10 Removing the Binding Posts	79
7.11 Installing the Binding Posts	79
7.12 Waterproof Connector (WPC) Assembly Rebuild	81
7.13 Waterproof Connector (WPC) Pin Diagrams	82
7.14 Post Dive Maintenance	82
Appendix Breathing Gas Requirements EXO Balance Regulator Full-Face Mask	85
8.2 Regulator Performance	85
8.2.1 EXO-BR® Regulator	85
8.2.2 Minimum Operating Temperature	85
8.3 Cage Code	85
8.5 CE Approved	85
8.5.1 CE Approved	85
8.5.2 Notifying Body	85
8.4 CR Standards	85
8.5.3 Notifying Body	86
8.6 Operational Specifications & Limitations for Surface-Supplied Diving	86
-Umbilical minimum I.D. 3/8" (9.5 mm) of not more than two sections, total length not to exceed 600 feet (183m).....	86
8.6.1 Using the EXO-BR Regulator with a Low Pressure Compressor Supply	87
8.6.2 Using the EXO-BR Regulator Low-Pressure Compressor Supply Pressure Requirements Table	87
8.6.3 Using a High-Pressure Breathing Gas Supply	91
Appendix II EXO Full-Face Mask Transport And Storage	93
9.1 Helmet Transport And Storage	93
9.1.1 One EXO® Full Face Masks	93
9.1.2 Two EXO® Full Face Masks	94
9.2 Use of Kirby Morgan Original Replacement Parts	95

About this Manual

The information in this manual is intended to aid the user in optimizing the performance of this mask. This manual gives reference to using EXO- 26 masks in open circuit scuba mode as well as in surface supplied diving mode. The use of some of this information will often depend on the use of associated support equipment and operational scenarios. It is not the intention of this manual to teach diving techniques, but rather to give the user the required technical information to allow Kirby Morgan helmets and masks to be integrated with the complete diving system.

Definitions of Signal Words Used in this Manual

For your protection, pay particular attention to items identified by signal words in this manual. These terms are identified as, CAUTION, WARNING AND DANGER. It is especially important for you to read and understand these sections.

CAUTION

This word indicates a potentially hazardous situation which, if not avoided, may result in minor or moderate injury. It may also be used to alert against unsafe practices.

WARNING

This word indicates a potentially hazardous situation which, if not avoided, could result in death or serious injury.

DANGER

This word indicates an imminently hazardous situation, which if not avoided, will result in death or serious injury.

If English is not your native language and you have any difficulty understanding the language of any warnings as they appear in the manual, please have them translated.

WARNING

Este é um aviso importante. Queira mandá-lo traduzir.

WARNING

Este es un aviso importante. Sirvase mandarlo traducir.

WARNING

Quest è un avviso importante. Tradurlo.

WARNING

Ceci est important. Veuillez traduire.

WARNING

Diese Mitteilung ist wichtig. Bitte übersetzen lassen.

If you have any questions regarding the information in this manual, or the operation of your mask, call KMDSI at (805) 928-7772

IMPORTANT SAFETY INFORMATION

This EXO Full Face Mask is intended for use by trained divers who have successfully completed a recognized training course in the use of a full face mask, and if used in the surface supplied mode, an approved surface supplied diving course. Read this manual before using or maintaining the mask, even if you have experience with other full-face masks. If you have purchased the mask new from a dealer, be sure to send in the warranty registration card so we may keep you in-

WARNING

Follow all the instructions in this manual carefully and heed all safety precautions. Improper use of this diving mask could result in serious injury or death.

WARNING

Kirby Morgan Dive Systems, Inc. (KMDSI) warns all divers who use the EXO Full Face Mask to use only KMDSI original spare parts from a KMDSI authorized dealer. Although other parts, O-rings and fittings may not to be manufactured to the same standards maintained by KMDSI. The use of any spares other than KMDSI original parts may lead to equipment failure and accidents.

WARNING

Diving in an environment that is chemically, biologically, or radiologically contaminated is extremely hazardous. Although the EXO Full Face Mask may be adapted for use in some contaminated environments, special training, equipment, and procedures are necessary. Do not dive in a contaminated environment unless you have been thoroughly trained and equipped for this type of diving.

WARNING

Diving is a life threatening occupation. Even if you do everything right you can still be killed or injured. None of the models of full-face masks can prevent accidents, injuries or death due to improper training, lack of health, improper supervision, improper job requirements, improper maintenance or acts of God.

WARNING

DO NOT dive this mask in water containing high concentrations of petroleum based chemicals. DO NOT use any chemical locking liquids anywhere on the mask. DO NOT use any type of aerosol sprays on the mask. These chemicals can attack, damage, and compromise the structural integrity of the plastic parts on the mask. Clean the mask using only mild soap and water.

formed regarding any safety notices that affect this product. If you resell or loan this mask to another diver, be sure this manual accompanies the mask and that the person reads and understands the manual.

This manual is supplied to the original purchaser of this mask. If you have any questions about the use of the mask or you need another copy of this manual, Part Number 100-030, contact KMDSI. If you have any questions regarding the use, maintenance, or operation of this mask, contact KMDSI at (805) 928-7772

All Kirby Morgan helmets, masks, and low pressure demand regulators must not be used with oxygen mixtures in excess

! WARNING

This mask was completely checked and should be ready to dive as it was shipped from the factory. However, it is always the diver's responsibility to check all the components of the mask prior to diving.

! WARNING

The EXO comes from the factory lubricated for oxygen service. If the exo is to be used for enriched air or oxygen use it must be carefully maintained and cleaned in accordance with this manual. components requiring Lubrication must be only be lubricated with an oxygen compatible lubricant such as Christo Lube or Krytox. Any breathing mixture containing an oxygen content greater than 23% oxygen is considered enriched gas.

of 50% oxygen by volume without first ensuring all low pressure (less than 225 psig, 15.5 bar) gas transporting components have been cleaned for oxygen service. Only oxygen compatible lubricants such as Krytox™ and ChristoLube™ should be used on components requiring lubrication and lubricants should be used sparingly. **Never** mix different types of oxygen compatible lubricants. Helmets or masks used primarily for air diving and occasionally for enriched gas use should be cleaned at more frequent intervals than helmets used for mixed gas diving only.

The Kirby Morgan SuperFlow 1st stage scuba regulator, as well as all Kirby Morgan dive control consoles and high-pressure gas components (greater than 225 p.s.i.g., 15.5 bar) should not be used with pure oxygen, Nitrox, or any breathing gas containing more than 23.5 % oxygen by volume. The first stage is not intended for use with enriched gas mixtures.

! WARNING

KMDSI regards the use of any breathing gas mixture greater than 50% oxygen to be treated as oxygen. This belief is in keeping with the recommendations set forth by the National Fire Protection Association (NFPA), Compressed Gas Association (CGA), and the American Society for Testing and Materials (ASTM).

! WARNING

Kirby Morgan “High Pressure Components” (greater than 225 p.s.i.g., 15.5 bar) must not to be used with pure oxygen, Nitrox, or any breathing gas mixtures with oxygen content greater than 23.5 % by volume. Using oxygen mixtures in excess of 23.5 % by volume may lead to a fire or explosion, which could result in serious injury or death.

! WARNING

Any diving helmet, full face mask, regulator, control console or breathing life support item manufactured or sold by KMDSI must not be used with breathing gas mixtures in excess of 50% oxygen without first ensuring that all gas transporting components have been cleaned for oxygen service, have oxygen compatible soft goods lubricated with an approved oxygen compatible lubricant such as Krytox or Christo Lube grease.

Operational specifications and limitations for surface supplied air diving and scuba diving for United States use, and a separate chart for European Union use are presented on Page 4. The information has been separated because of the differences imposed or required by certain regulating bodies. Whenever Kirby Morgan diving equipment is used in countries that have adopted CE Certification, only CE certified components can be used and all components must be part of the tested certified configuration.

It is important for the user to understand the rules, regulations, and philosophy imposed by the governing or regulating bodies whenever diving operations are being planned or conducted. Diving operations must only be conducted within the limits of the operational specifications, and in accordance with the rules and regulations established by the governing authority in the specific country or geographical location where the diving operations are being conducted. Technical questions regarding this equipment should be directed to Dive Lab Inc., of 1415 Moylan Road, Panama City Beach Florida. Telephone 850 235-2715, Fax 850-235-0858 e-mail - divelab@aol.com

The original language of the Kirby Morgan Manuals is English. Translation into other languages will be provided upon request. KMDSI may charge a fee for these services.

Warranty Information

Kirby Morgan Dive Systems, Inc. warrants every new mask, helmet, or KMAC Air Control System to be free from defects in workmanship for a period of three hundred sixty five (365) days from date of purchase. This warranty covers all metal, fiberglass, and plastic parts. This warranty does NOT cover rubber parts, communications components, or headliners. In addition, due to the electrolytic nature of underwater cutting and welding, chrome plating cannot be warranted when the diver engages in these activities.

Should any part become defective, contact the nearest authorized KMDSI dealer. If there is no dealer in your area, contact KMDSI directly at (805) 928-7772. You must have a return authorization from KMDSI prior to the return of any item, Upon approval from KMDSI, return the defective part, freight prepaid, to the KMDSI plant. The part will be repaired or replaced at no charge as deemed necessary by KMDSI.

This warranty becomes null and void if:

- 1) The product is not registered with KMDSI within ten (10) days of purchase.**
- 2) The product has not been properly serviced and/or maintained according to the appropriate KMDSI manual. In addition, the user is responsible to ensure that all product updates as recommended by KMDSI have been performed.**
- 3) Unauthorized modifications have been made to the product.**
- 4) The product has been abused or subjected to conditions which are unusual or exceed the product's intended service.**

NOTE: Be sure to complete the enclosed warranty card and return it to KMDSI immediately. No warranty claims will be honored without a satisfactorily completed warranty card on file at KMDSI.

EXO Balanced Regulator Full-Face Mask



Chapter 1

General Information KMDSI Products



This manual will refer to location numbers in specific drawings, or in the exploded view, which is in the back of this manual. These numbers are called “location” numbers. They are used to find the referred to parts in the drawings in this manual only. They are not the part number. Next to the exploded drawing is a list of the “location” numbers that match the Kirby Morgan part numbers along with the name of the part. Always check the part number when ordering to make sure it is correct. When ordering, always specify the helmet model number and serial number as well.

1.1 Introduction

The Kirby Morgan Corporation was started in 1965. The copper and brass “heavy gear” or “Standard Dress” helmets were the first helmets manufactured by the company. Over the years Kirby Morgan designed, manufactured and sold many different helmets and masks for commercial divers.

Staying active in commercial diving has contributed to the successful design innovations of KMDSI products. This may be the primary reason for the acceptance of our designs by professional divers.

Bev Morgan has designed more than Fifty-Seven diving helmets and over 40 diving masks. All employees of KMDSI participate as part of the Kirby Morgan design team. It would not be possible for us to supply the commercial, military, scientific, and public service diving industries with our equipment, without the team of people that make up Kirby Morgan Dive Systems, Inc. (KMDSI)

We feel it is important for the reader to understand that we at KMDSI consider ourselves as only part of the process along the path in diving equipment design. We welcome all input from our customers. The thinking of many good divers, diving equipment engineers, diving medical specialists, diving organization administrators and their supporting personnel has contributed to the current state of the art of diving.

Within each piece of equipment we manufacture is some of the thinking of those who have come before us. To all those individuals who gave something of themselves for the men and women who work underwater, we express a thank you.



*Bev Morgan, Chairman of the Board
Kirby Morgan Dive Systems, Inc.*

We have a strong commitment to providing the best diving equipment and service possible. This thinking has been the policy of Kirby Morgan Dive Systems, Inc. and we will continue to take this approach to our work.

Our extensive dealer network makes it easy to obtain genuine Kirby Morgan replacement parts, as well as technical assistance worldwide.

KMDSI has always concentrated on designing and manufacturing diving equipment that allows most repairs, inspections, and all routine maintenance to be performed by the user. Most routine preventative and corrective maintenance can be accomplished by using this manual, the KMDSI Tool Kit (P/N 525-620 or 525-768) and common hand tools. Technician training is available through Dive Lab Inc., information can be obtained on line at www.divelab.com or by telephone at 850-235-2715.

1.2 Full-Face Masks and Manifolds



KMB® 18B

CE approved and CR™ marked

The **KMB 18B Band Mask** frame is constructed of hand laid fiberglass. The head harness is a molded, strong tear resistant neoprene rubber.

The hood, which attaches to the mask frame with welded stainless steel bands, provides warmth for the divers head as well as pockets for the earphones. The communications connections can be either a male waterproof plug in type or bare wire posts. Both this mask and the KMB 28B feature the new Tri-Valve™ Exhaust System.

The **KMB 28B Band Mask** (not shown) is very similar to the KMB 18, with many parts on the KMB 18B being interchangeable with the KMB 28B. The major difference between the 18 and 28 is the material of the mask frame. The KMB 18 has a fiberglass frame (yellow) while the KMB 28B frame is an extremely durable injection molded plastic (black).

Other differences include:

- 1) The main exhaust body of the KMB 28 is part of the frame itself and uses a #545-041 main exhaust cover
- 2) no comfort insert is required on the 28
- 3) the face ports for the 18 and the 28 differ slightly in size.

Both the 18 and 28 are CE approved.

The **EXO Full Face Mask** is designed for both surface supplied and scuba diving. By enclosing the divers eyes, The **EXO Full Face Mask** is designed for both surface supplied and scuba diving. By enclosing the divers eyes,

nose and mouth, the EXO permits nearly normal speech when used in conjunction with most wireless, and all hardwire underwater communication systems.



EXO® BR

CE approved and CR™ marked

The **EXO BR (BALANCED REGULATOR)** shown here is designed to meet or exceed recommended performance goals in both scuba and surface supplied modes and is CE approved. It meets and surpasses European standards for regulator performance.

The Balanced Regulator helps reduce the work of breathing for the diver by balancing the intermediate air pressure against the valve sealing pressure inside the regulator. This enables the regulator to instantly adjust to changes in line pressure. The balanced regulator is adjustable for a wide range of intermediate pressures between 90 PSIG – 250 over ambient pressure (6.2 – 17 bar).

Both models have a modular communications design that permits rapid and simple maintenance. The optional Hard Shell provides surfaces for mounting lights, cameras etc.



*SuperMask M-48
w/ Scuba Pod*



*M-48 Mod-1
w/ Scuba Pod*

CE approved and R™ marked



The **SuperMask M-48** and the **M-48 Mod-1** are innovative new designs in full-face masks. They provide the diver with all the comfort of a full-face mask with the convenience of changeable second stage regulators as well as the ability to use a snorkel without having to remove the mask.

The masks are comprised of two major components, the mask frame and the interchangeable lower pod. The removable lower pod is a feature unique to the M-48 full-face masks. When diving, the pod is easily removed and replaced on the mask, providing the diver the capability to buddy-breathe, snorkel, use an octopus or perform an “in water” gas switch.

With the pod sealed to the mask, the flexible, silicone pod cover allows the diver to quickly place the regulator mouthpiece into the mouth or dive with it free of the mouth for communications. With the mouthpiece in, the regulator may be used without the pod being sealed to the mask.

The masks may also be used surface supplied when used with the proper accessories. We are currently developing several different pod configurations for both open circuit and rebreather use. For further information, see the M-48 Frequently Asked Questions (FAQ) area on our web site at <http://www.kirbymorgan.com/products/full-face-mask/m-48-supermask>.



*KMACS-5
w/ No Communications*



*KMACS-5
w/ Communications*

The **Kirby Morgan Air Control System-5 (KMACS)** is a lightweight, portable control box for use in surface supplied air diving operations. The KMACS-5 controls the diver’s air supply, communications and monitors the diver’s depth. It allows two divers clear push-to-talk (two wire) or round robin (four wire) communications. The KMACS-5 is also available without communications.

The air supply can be either from a low-pressure compressor or high-pressure cylinders. The adjustable first stage regulator reduces the high-pressure air and supplies low pressure through the umbilical to the diver’s breathing system.

High pressure yokes permit U.S. standard scuba cylinders or DIN equipped cylinders to be used. Low-pressure air supply fittings allow for a compressor to be used as the primary air source.

A complete pneumo system with dual reading gauges (both US Standard and Metric) is provided for each diver’s air, as well as a shut-off/bleed system that uses two high-pressure feed lines which allows changing of used cylinders without interruption of the diving operation. Optional shut off valves allow the isolation of each diver’s air supply.

The communicator is a multipurpose intercommunication system that provides reliable and clear communications between a topside operator (tender) and one or more surface-supported divers, recompression chambers, or other submersible systems.

1.3 Kirby Morgan Diving Helmets

All Kirby Morgan diving helmets and masks are manufactured by Kirby Morgan Dive Systems, Inc. (KMDSI). Each step of the manufacturing process is carefully controlled to assure the customer of a high quality, durable helmet that will function properly for many years.

There are nine Models of Kirby Morgan diving helmets currently in production. They are the SuperLite®-17B, SuperLite® 17C, SuperLite® 27®, and Kirby Morgan models 37, 37SS, 47, 57, 77 and 97. All are  marked.



The **SuperLite®-17 A/B** was first developed in 1975 and quickly set a new standard for diving helmet design. Many large and small commercial diving companies, military organizations, scientific divers, and public safety divers are successfully using this design around the world. This helmet is  marked. The SL 17B is equipped with the small tube, SuperFlow® adjustable regulator.

The SL-17 A/B helmet system consists primarily of two major components: the neck dam/yoke assembly, and the helmet. To don the helmet, the diver first slips the angled neck dam with the attached yoke over his head. The helmet is lowered onto the diver's head with the help of a tender, then the yoke hinge tab is hooked onto the alignment screw on the rear weight. The neck clamp is then slipped onto the helmet and locked. The locking system not only seals the neck dam to the helmet but also secures the front of the yoke, fastening the helmet to the diver's head.

The **SuperLite®-17 A/B** shares many common breathing system parts with all Kirby Morgan helmets and masks. The breathing system was man-tested to 1600 FSW by the University of Pennsylvania and approved by the U.S.

Navy for surface-supplied diving to 190 FSW with air and 300 FSW with mixed gas. It surpasses all requirements of all governing agencies and it is approved for commercial diving through out the world.

Other features that are common to all Kirby Morgan helmets include:

- * Face port and retainer ring
- * Communications components
- * Oral/nasal mask
- * Nose block device
- * Air train/defogger



The **SuperLite® 27®** Commercial Diver's Helmet represents what we at Kirby Morgan consider to be a turning point in modern diving helmet design. With a smaller, low volume shell design, this helmet is often preferred by persons with smaller heads.

The chrome plated machined brass helmet neck ring houses the sealed pull pins and provides protection for the bottom end of the helmet. Like the SL-17K, 37 and 17C, the diver is provided with an internally adjustable chin support. This support, along with the adjustable neck pad on the locking collar, gives the diver a comfortable, secure, custom fit.

The quick-change communications module, available with either bare wire posts or a waterproof connector, allows for easy, efficient maintenance of the helmets communications.

The helmet also features the SuperFlow® 350 large tube adjustable demand regulator. The helmet is available in the umbilical over the shoulder, "B" configuration only.

The SL 27 comes standard with the exceptionally dry Tri-Valve exhaust system.



Kirby Morgan® 37



CE approved and CR™ marked

The **Kirby Morgan 37** Commercial Diver's Helmet has basically the same features of the SL 27. The helmet consists of two major assemblies: the helmet shell/helmet ring assembly and the neck dam/neck ring assembly.

The helmet comes with the large tube SuperFlow® 350 adjustable demand regulator which provides an easier breathing gas flow during peak work output. The quick change communications module is available with either bare wire posts or a waterproof connector. The KM 37 comes equipped with the extremely dry Quad-Valve exhaust system.

The helmet ring houses the sealed pull pins and provides protection for the bottom end of the helmet. The diver is also provided with an internally adjustable chin support. This custom fit and balance seats the helmet comfortably for long periods of time even when working in the face down position.



Kirby Morgan® 47



CE approved and CR™ marked

The **Kirby Morgan 47** offers the ultimate in a high performance breathing regulator, the REX®. The all stainless steel REX® regulator, with its fully adjustable balanced piston, is a breakthrough design that exceeds the requirements of all government or other testing agencies.

The KM 47 has the best work-of-breathing performance when compared to ANY other commercial diving helmet (except the KM 77, which also features the REX® regulator). The Kirby Morgan 47 Dive Helmet has been tested and meets or exceeds European CE requirements and is fully commercially rated. In all other respects, this helmet is nearly identical to the Kirby Morgan 37.



Kirby Morgan® 57



CR™ marked

The **Kirby Morgan 57** helmet features our revolutionary new SuperFlow® 450 Stainless Balanced Regulator. It's machined from a stainless steel casting for the ultimate in performance and reliability.

Like all KMDSI regulators on our helmets and Band Masks®, we use only regulators that are specifically designed for surface-supplied diving, that will perform over the wide range of pressures delivered by low pressure compressors. An ordinary scuba regulator mounted on a diving helmet is not capable of delivering the gas you need at heavy work loads. This commercially rated, balanced, adjustable regulator delivers all the breathing gas you would require for the most demanding work underwater.

The **Kirby Morgan 57** also includes our Quad-Valve™ Exhaust System. It's recommended for diving in biologically contaminated water, when you're properly trained and equipped, using recommended procedures. This new exhaust has exceptionally low exhalation resistance that you must experience to appreciate.

WARNING

Before attempting any diving in any type of contaminated water, a complete diving and topside course in hazardous materials emergencies should be completed. The divers and the topside team must be properly trained and have the proper safety equipment. All helmets and suits can leak water under certain conditions. Divers should use extreme caution when diving in contaminated waters.



Kirby Morgan® 77

CE approved and R[™] marked

The **Kirby Morgan 77** represents the first of our stainless steel generation of helmets. The stainless steel helmets incorporate our most advanced features and innovations, as well as provide the alternative for the diver that prefers a metal helmet over fiberglass. The KM 77 features the stainless steel REX[®] regulator, which offers the best performance of any Kirby Morgan breathing system.

The KM 77 has the best work-of-breathing performance when compared to ANY other commercial diving helmet (except the KM 47, which also features the REX[®] regulator). The Kirby Morgan 77 Dive Helmet has been tested and meets or exceeds European CE requirements and is fully commercially rated.

The advantages of the stainless steel helmets include:

- Extremely rugged shell and other components (less maintenance)
- No refinishing required if the surface is scratched or gouged.
- Faster production of helmets for customer delivery.
- Elimination of separate threaded inserts for securing the port retainer to the helmet shell.
- No need to remove the handle to change out the view port, its O-ring, or the port retainer.
- One piece sideblock includes both the free-flow valve and the Emergency Gas System valve.
- The bottom ring is an integral part of the stainless steel helmet shell (not a separate part as on fiberglass helmets).



Kirby Morgan® 37SS

CE approved and R[™] marked

The **Kirby Morgan 37SS**, like the KM 77 and KM 97, features an all stainless steel shell, a stainless sideblock, port retainer, handle, and other key components. The SuperFlow[®] 350 regulator is standard on this helmet.

The Kirby Morgan 37SS features a quick change communications module, available with either bare wire posts or a waterproof connector, and allows for easy, efficient maintenance of the helmet's communications. This same communications system is found in all our helmet models with the exception of the SL 17B and 17C.



Kirby Morgan® 97

The **Kirby Morgan® 97** features the 455 Balanced Regulator which is an all Stainless Steel regulator of a balanced design that offers far greater overall breathing performance than the non-balanced SuperFlow® and SuperFlow® 350 regulator. The 455 has virtually the same breathing performance as the REX® regulator, but is designed to be used with the SL 27®, 17C, KM 37 and KM 37SS helmets. The overall performance of this regulator is outstanding and sets a new performance standard for commercial diving helmets.

The Kirby Morgan 97 features a quick change communications module, available with either bare wire posts or a waterproof connector, and allows for easy, efficient maintenance of the helmet's communications. This same communications system is found in all our helmet models with the exception of the SL 17B and 17C.

Chapter 2

Operating Instructions

2.1 Introduction

This section provides the manufacturer's recommendations on how to use the three EXO Full-face Masks. The use of these diving masks will vary with the type of diving and environmental conditions. A proper training program in the use of full-faced masks must be undertaken prior to diving the mask.

Practice using the mask in a calm, clear body of water (pool) before open water diving. There is a video available from Team Visions that goes over many of these basic procedures. The video, Diving With The EXO-26 Full-face Mask is available from Best Publishing PO Box 30100 Flagstaff Ariz. 86004 Ph 800 468-1055.

2.2 First Use and Pre-Dive Set-Up

When you first receive your EXO Full-face Mask, carefully unpack it and examine it for any damage that may have occurred during shipment. Use the inspection sheet provided to ensure that no damage has occurred! Read all warning labels & caution tags.

Be sure to complete the enclosed warranty card and return to KMDSI as soon as possible. Warranty claims require that a card be on file at KMDSI 10 days after purchase. Incomplete warranty cards are considered invalid.

2.3 Pre Dress-in Procedure

Before dressing in for a dive, an inspection of the mask and all related gear should be made to ensure everything is in proper working order. This should be done well in advance of the dive, so any problems or adjustments can be dealt with. ***Read and understand this manual before you dive.*** Chapter 2 tells you the basic operating procedures and how to perform the pre-dive mask inspections and pre-dive regulator function tests.

2.4 Visual Inspection

Visually inspect the entire exterior and interior of the mask.

- The face seal should be in good condition with no cracks, tears, or punctures.

- The spider (head harness) should be intact. Stretch the spider and inspect it carefully for signs of cracking or tearing.

- Inspect the face port. It should be clean and clear. Anti fog solutions should be applied prior to use.

- Check the wiring for the communications, if present. Make sure the communication module mount nut is screwed down tight.

- In the EXO Original, inspect the air inlet tube and make sure it is properly seated on the regulator.

- In the EXO Standard or BR, inspect the oral nasal and equalizer and make sure they are securely mounted. If the mask does not have communications installed, be sure to use a microphone hole plug (320-001) in the oral nasal.

- Check the regulator assembly to ensure that it is secured tightly on the mask frame.

- Check the regulator cover to ensure that it is tight on the regulator body.

- With no air to the mask, screw the regulator adjustment knob all the way out and back in to ensure that it turns freely.

2.5 Clean Face Port

Remove any sand or debris from the interior of the mask and face port which may be inhaled or blown into the divers face, interfering with the diver's vision.

Under certain conditions, depending upon water temperature, you may find it necessary to prep the mask lens to keep it from fogging while diving. There are a number of commercial defoggers available for scuba diving which work well. Follow the directions on the label for use.

If no commercial preparation is available it is possible to use soap. Use a small amount of liquid soap on a rag and smear a thin film on the inside of the lens. Do not rinse this film off. Apply the soap just prior to entering the water.

2.6 Adjusting the Equalizer EXO Standard or BR

There are different height positions that the equalizer can be adjusted to. Carefully peel the equalizer out of the wire retainer and reposition it in another one of the molded grooves in the equalizer. The wire retainer can also be slightly bent in one direction or another, up or down, to get the angle of the equalizer just right. Ensure that the corners of the equalizer grooves are "snapped" into position on the wire retainer so that it does not come loose.



The equalizing device can be adjusted to the precise height and position that you need.

2.7 Checking Regulator Functions & Preparing the EXO for Use In SCUBA Mode.

Attach the low-pressure hose that is supplied with the mask to the low-pressure (L.P.) port on your 1st stage regulator and then to the mask. Never connect the hose or mask to a high pressure (H.P.) port. When attaching the hose to the regulator **ALWAYS USE A BACK UP WRENCH ON THE NIPPLE TUBE.**

The included angle swivel provides more comfort with at a variety of head positions. KMDSI recommends always using this attachment.

Prior to attaching your first stage regulator to your tank be sure the regulator adjustment knob on the mask is screwed all the way in. This will prevent the regulator from free flowing when the air is turned on.

! CAUTION

If you are not using the inlet angle fitting, a backup wrench must be used on the hex fitting of the regulator when tightening. Otherwise the regulator may come out of adjustment!



Always use a back-up wrench when attaching or removing a hose to the regulator. Note the angle swivel in use.

! WARNING

A submersible pressure gauge is considered essential for full-face mask scuba diving. The diver must plan his dive to avoid running out of air while wearing a full-face mask. There is no way to safely buddy breathe underwater, use an octopus rig, or snorkel on the surface while wearing a the EXO full-face mask. If the submersible pressure gauge should fail during the course of a dive, the dive should be terminated immediately.

Your 1st stage regulator should be equipped with a submersible pressure gauge. Attach the first stage to your tank and turn the air on while holding the submersible pressure gauge away from you. Once the air is on, check the pressure gauge to ensure you have a full tank.

To check the EXO-standard and BR regulators for proper function and adjustment, first ensure the demand regulator adjustment knob is in fully clockwise then bring up a gas supply at between 135-150 psig. Slowly back out on the adjustment knob counterclockwise until a slight free flow develops then adjust in until the free flow just stops.

At this point lightly depress the purge button, the button should only travel between 1/16th to 1/8" before a flow is started. If the button travels less than 1/16" or greater than 1/8" before flow starts the regulator will need to be adjusted (see chapter 6)

Higher first stage regulator pressures may cause free flow, but turning the regulator adjustment knob in should stop the flow. In the unlikely event there is still flow, proceed to the regulator adjustment section in Chapter 6 to reset the regulator.

2.8 Test the Regulator

Loosen all the straps on the spider and hold the mask on your face. Take a couple of good breaths, breathing slow and soft at first then hard and fast. The regulator should be operating with the minimal amount of breathing resistance and no free flowing.

Any type of an air flow "hiss" should be able to be adjusted out by using the adjustment knob. If the adjustment knob is adjusted all the way in and the regulator still hisses, see the regulator adjustment section, Chapter 6.

Pressing the purge button should cause a fairly strong air flow into the mask. If there is no flow when pressing the purge button, or if breathing is difficult, see the regulator adjustment section in Chapter 6.

Once you enter the water, the regulator can be adjusted for a variety of diving conditions and positions just by turning the adjustment knob in or out.



Always test the function of your regulator prior to entering the water.

2.9 Wireless Communications

There are several manufacturers that produce a wireless communications unit that can be used with the EXO Mask. If you are using wireless communications read and follow all of the manufacturer's instructions for your particular unit.

If you are using wireless communications you should test the communications by placing the transducers from both send and receive units in a bucket of water and speaking into the mask. Communications should always be tested prior to the diver entering the water.



Your wireless system must not be attached to your weight belt.



WARNING

The waterproof case for your wireless communications unit should only be attached to your scuba backpack, **NEVER** to your weight belt. In the event your belt must be dropped the belt must have a clear drop path and must not be connected to any other piece of gear. If this procedure is not followed the weight belt and wireless electronics case will be attached to the mask by the connecting wire. This could cause the mask to flood, leading to drowning.

2.10 Using the EXO in the Surface-Supplied Mode

If you have not been trained in the proper use of surface-supplied diving equipment we strongly recommend that you complete a training course in the use of this equipment prior to diving in the surface-supplied mode.

Read and understand the Checking Regulator Function and Preparing The EXO for use in scuba mode section of this chapter. The basic connecting instructions of the mask and regulator function tests are the same.

The one way valve is a very important component. It prevents the flow of air out of the mask in the event of a sudden lowering of pressure in the umbilical supply hose due to an accidental break in the hose or fitting. Not only would the emergency air be lost if the one way valve failed (concurrent with a hose or fitting break) but the diver could be “squeezed”, a very serious accident. Do not dive in the surface-supplied mode without a one-way valve.



The EXO-BR works well in the surface-supplied mode.

At a minimum, if the EXO is to be used for surface-supplied diving the following systems and components must be in place and in proper working condition:

- 1) **Air Supply:** Either a low-pressure compressor or high pressure air bottles. (See operating specifications)
- 2) **Dive Control System:** An air management box to control the flow of air delivered to the diver or divers (like the KMACS-5 - Kirby Morgan Air Control System - offered by KMDSI).
- 3) **Diver's Umbilical:** Hose bundle consisting of air supply hose, pneumofathometer hose (depth sensing), communications wire and rope as a strength member.
- 4) **Diver's Manifold Block:** A metal block that has a one way valve that the umbilical attaches to, an emergency valve that the bail out system attaches to and L.P. ports for attaching the mask hose, dry suit inflators and other accessories.

- 5) **Bail-out System:** Consisting of a harness, bail out

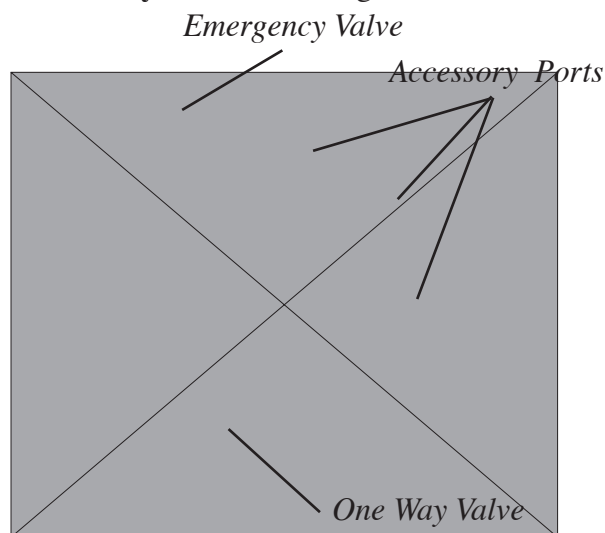

KMDSI Manifold Block Assembly



WARNING

The EXO Mask is not equipped with a one way valve (non-return valve) as supplied from the factory. For surface-supplied diving, the diver must use a manifold block equipped with a one way valve. Do not connect the diver's umbilical directly to the EXO without a one-way (non-return) valve. In the event of a rupture of the hose, this can lead to a squeeze, a potentially fatal accident.

! WARNING

Never dive if the one-way valve is not operating properly. If the hose or breathing gas/air fitting breaks near the surface a serious injury could result to the diver's lungs and/or eyes. In extreme cases this could be fatal. The one-way valve must be tested daily prior to the commencement of diving operations.

! WARNING

The one-way valve must be tested daily, prior to commencement of diving operations. Failure of the one-way valve could cause serious injury or death.

! WARNING

If the one-way valve or the adapter is loosened this will allow breathing gas to leak out of the breathing system. This could also result in a loss of all pressure to the mask, leaving the diver with nothing to breathe.

bottle, first stage regulator with over pressure relief valve. This system connects to the emergency valve on the divers manifold block assembly by a hose.

6) Communications System: Provides hard wire communication between diver and topside.

2.11 Testing the Manifold Block

Prior to assembling a bail-out system, the one way valve and emergency valve should be tested for proper function.

Equipment Needed:

- Manifold Block
- Bail-out bottle
- 1st Stage regulator w/octopus and scuba reg hose attached
- KMACS-5 system with an umbilical supply hose
- Bucket of water

2.11.1 Testing the One-Way Valve

1) With all the accessory holes plugged on the manifold block, attach the SCUBA type regulator hose from a first stage regulator that also has an octopus attached, to the emergency valve on the manifold block assembly. The octopus will be used for depressurization once the test is concluded.

2) Connect the first stage to the bail-out bottle, open the emergency valve all the way, and pressurize the system.

3) Place the pressurized manifold block in a bucket of water and check the one way valve for leaks. No air should leak through the one way valve or from anywhere else on the manifold block assembly. If there is a leak, the one way valve **MUST** be rebuilt or replaced.

4) As a secondary test, close the emergency valve trapping pressure inside the manifold block assembly and relieve the pressure on the first stage using the octopus. Disconnect the hose from the emergency valve.

5) Quickly open the emergency valve by turning the knob. You should hear the trapped air escaping through the emergency valve.

2.11.2 Testing the Emergency Valve

1) With all the accessory holes plugged on the manifold block, attach the umbilical hose to the one way valve.

2) Make sure that the emergency valve is closed all the way and pressurize the umbilical.

3) Place the pressurized manifold block in a bucket of water and check the emergency valve for leaks. NO air should leak through the emergency valve or from anywhere else on the emergency valve assembly or manifold block assembly. If there is a leak, the emer-

gency valve **MUST** be rebuilt or replaced.

4) Turn the umbilical off and open the emergency valve to depressurize the system and disconnect the hose.

2.12 Diver's Harness

The harness provides an attachment point for the manifold block, tools the diver may use while in the water, and the "D" ring where the umbilical shackle connects. The umbilical shackle must connect to the strength member of the umbilical.

The manifold block attaches to the harness and the harness is the primary attachment point for the diver's umbilical using a snap shackle. Arrange the umbilical so it attaches to the harness, then to the manifold block on the harness. This helps eliminate the possibility of a direct pull on the diver's mask by top-side.

The harness may also be used to lift an unconscious diver from the water and should be of sturdy construction. It should be equipped with a jock/crotch strap for lifting purposes.

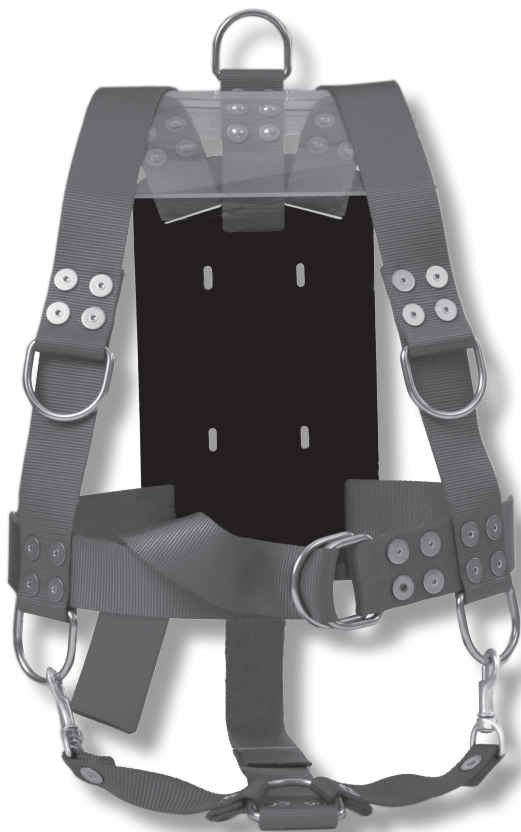

A well designed diver's harness must be rugged. This harness can be equipped with a crotch strap, or "jock."

2.13 Installing the Manifold Block on the Diver's Harness

The manifold block assembly is designed to be worn on the diver's harness. Most divers prefer to attach the manifold block to the right side of the diver's harness. The shackle which attaches the umbilical to the harness "D" ring, is usually located on the left side. After attaching the umbilical to the "D" ring on the left side of the harness, the umbilical is normally routed behind the diver's back to the manifold block.

To attach the manifold to the diver's harness:

- 1) Remove one of the screws which holds the mounting plate on the manifold block body and loosen the other screw to provide enough clearance for a harness strap.
- 2) Swing the plate to one side and position the manifold block on the harness.
- 3) Swing the plate back into the correct mounting position and thread the screw through the plate and into the manifold body.
- 4) Tighten both screws until the harness is compressed between the manifold and mounting plate holding the manifold block assembly in place.

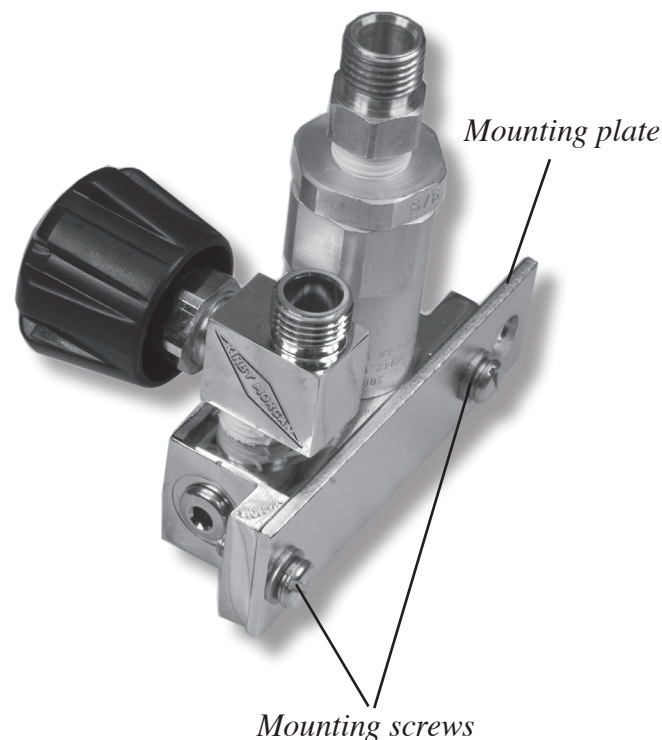

2.14 Bail-Out Bottle (Emergency Air Supply)

The diver should always dive with a bail-out bottle when diving with surface-supplied air, no matter how experienced the diver or how shallow the water depth. Should the diver become unexpectedly entangled underwater, or if the top side air supply fails, the bail-out bottle may provide the few extra minutes of air the diver needs to deal with the emergency and get to a safe place.

The size of the bail-out bottle should be determined by the water depth, the penetration distance, or the probability of entanglement of the diver. Deeper dives, or distant penetrations can be made with greater confidence with larger bail-out bottles. Dives which require the use of a larger bail-out bottle include, but are not limited to, deep dives and penetration dives.



The diver should always be equipped with a bail-out bottle.

! WARNING

Do not dive without a diver worn Emergency Gas System. If the main gas supply is lost, you will have nothing to breathe and may drown.

2.15 First Stage Regulator

The first stage regulator used on the bail-out bottle should be a high-flow unit. A submersible pressure gauge must be connected to the regulator to enable the diver to monitor the status of his bail-out supply.



Use a high-quality first stage for your bail-out system.



The bail-out system must have a submersible pressure gauge for the diver to monitor the gas supply.

! WARNING

A standard Scuba submersible pressure gauge must be connected to the high pressure port on the first stage so that the diver can monitor his emergency supply.

2.16 Over-Pressure Relief Valve

When using the EXO, the first stage regulator should be fitted with an overpressure relief valve. This valve is included with the EXO-BR and must be installed, using 20 inch pounds torque, into a low-pressure port on the first stage regulator. It is also highly recommended that the valve be used with the EXO Original and EXO Standard, as well as any surface-supplied diving system, anytime a bail-out system is used.

The purpose of this valve is to allow the regulator to bleed off excess pressure should the first stage develop an internal leak. If the first stage leaks and this valve is not present, the pressure between the regulator and the emergency valve on the manifold block could increase until the hose ruptures. This will cause a complete loss of the bail-out supply. It could also lead to injury of the diver due to the whipping action of the hose.

Order KMDSI Part # 200-017, High Flow Overpressure Relief Valve.



An over-pressure relief valve needs to be installed on the first stage of the regulator used for bail-out. It must only be connected to a low-pressure port. Torque specification for the P/N 200-017 over-pressure relief valve is 20 inch pounds.

! CAUTION

The first stage regulator must be equipped with an overpressure relief valve when using the EXO-BR. In the event the first stage leaks there is no way for the pressure in the hose attached to the emergency valve on the manifold block assembly to relieve itself. The hose may rupture if this occurs leading to a loss of bail-out supply and possible personal injury to the diver.

! WARNING

Never dive without an over pressurization relief valve installed on the EGS regulator (1st stage). Without the relief valve if the EGS regulator develops an internal leak, or carries-away, the full pressure of the EGS cylinder would be placed on the low-pressure EGS hose and the Emergency Valve. This could cause the low-pressure hose to burst resulting in the complete loss of the EGS system.

! WARNING

Decompression diving always involves the risk of decompression sickness. Omitted decompression due to loss of gas supply or other accidents can cause serious injury or death. The use of any Kirby Morgan full-face mask or helmet cannot prevent this type of injury.



2.17 Configuring Your Emergency Gas System

There are several possible ways to configure your emergency gas system, although at KMDSI we only recommend one method. The configuration we recommend is as follows:

Cylinder Valve Open - EGS Valve on manifold block closed.

This is the only method that we recommend. The advantages of this method are as follows:

- You only need to open one valve to activate your emergency supply.
- There is little danger of flooding your first stage regulator and ruining it.

Possible Emergency Gas Supply Cylinder & EGS Valve Configurations			
Configuration	Cylinder Valve	EGS Valve	Advantages/Disadvantages
Configuration 1 (Regulator pressurized)	 On	 Off	Advantages <ul style="list-style-type: none"> • One valve to open • First stage won't normally flood Disadvantages <ul style="list-style-type: none"> • If hose or first stage leaks some or all EGS gas will be lost
Configuration 2* (No pressure in regulator)	Off	On	Advantages <ul style="list-style-type: none"> • One valve to open • No loss of gas from cylinder if hose leaks or regulator leaks Disadvantages <ul style="list-style-type: none"> • First stage will flood and must be serviced after each day of diving
Configuration 3* (Regulator pressurized then cylinder valve closed)	On momentarily then Off	Off	Advantages <ul style="list-style-type: none"> • No loss of cylinder gas if hose or regulator leaks Disadvantages <ul style="list-style-type: none"> • Two valves to open in emergency • Slow leak on long dive may result in flooded 1st stage • If dive depth exceeds pressure in first stage, first stage will flood
Configuration 4*	Off	Off	Advantages <ul style="list-style-type: none"> • No use of cylinder gas unless emergency occurs Disadvantages <ul style="list-style-type: none"> • Regulator will flood and need service daily • Two valves to open in emergency

* Requires ability to reach cylinder valve without difficulty

There are risks with each method of configuring your bail-out system. There is a risk that if you have the bail-out bottle on and the emergency valve on the helmet closed, that the emergency gas could be lost if the hose or the first stage itself develops a leak. However, KMDSI believes that this method poses the least amount of risk for the diver.

Probably the most serious problem with any of the other possible configurations is that the first stage will almost certainly flood if it is not pressurized while you are underwater.

If the regulator floods and is not promptly serviced, it will not perform properly when you need it in an emergency. As a diver, you always must decide how much risk and what types of risk you are willing to expose yourself to when you dive. It's up to each individual to make an informed choice regarding how to configure your bail-out system. We cannot make this choice for you.



Always be sure to check the pressure in your bail-out bottle before you dive.

KMDSI strongly recommends the use of a submersible pressure gauge with every bail-out system. Not only does this make it very easy to check your emergency gas pressure prior to diving, it also allows you, in most cases, to periodically check the pressure in your system while you dive. In this way, if you have a leak, you will probably figure it out and will be able to take appropriate action.

! WARNING

Some divers, keep the EGS gas cylinder valve shut during the dive. Their rationale being; in the event of an emergency, they will simply open the EGS cylinder valve thus eliminating any EGS air/gas unknowingly being lost due to either a 1st stage failure or EGS hose failure.

KMDSI strongly recommends never diving with the EGS cylinder valve shut. The reasoning behind this is twofold. First, with the EGS cylinder valve open, gas is immediately available in the event of topside gas interruption via the EGS valve on the side block simply by opening it. Secondly, and most importantly, if the EGS regulator (1st stage) is not pressurized, during descent it is possible that sea water will leak through the first stage intermediate circuit and regulator, causing failure of the EGS regulator and resulting in possible injury or death.

! WARNING

Never connect the main gas supply hose from the diving control station to the Emergency Gas valve assembly (EGS). If this is done there is no one-way valve protection for the diver in the event of damage to the umbilical or related equipment. The diver could be exposed to a serious "squeeze". This can result in serious personal injury or death.

! WARNING

Never connect a high-pressure hose directly to the EGS valve assembly, as this will transmit the full pressure of the tank to the manifold block. The manifold block is not designed for high pressure and may burst. This may result in severe personal injury or death.

2.18 Connecting the Hoses to the Manifold Block

After the manifold block has been installed on the diver's harness you will need to attach the hoses to route the air supply. Be sure to use the correct size open end wrenches, not adjustable wrenches, for connecting the hoses. Adjustable wrenches tend to slip and may damage the brass fittings used on the hoses.

The manifold block has three low-pressure ports which will accept a standard U.S. regulator hose and one port in line with the one way valve, which will accept a low-pressure high flow hose. A low-pressure high-flow hose attached to this port and then to the mask will assure the maximum flow of air to the mask's regulator.

1) Attach the first stage regulator to the bail-out bottle, but do not turn the air on.

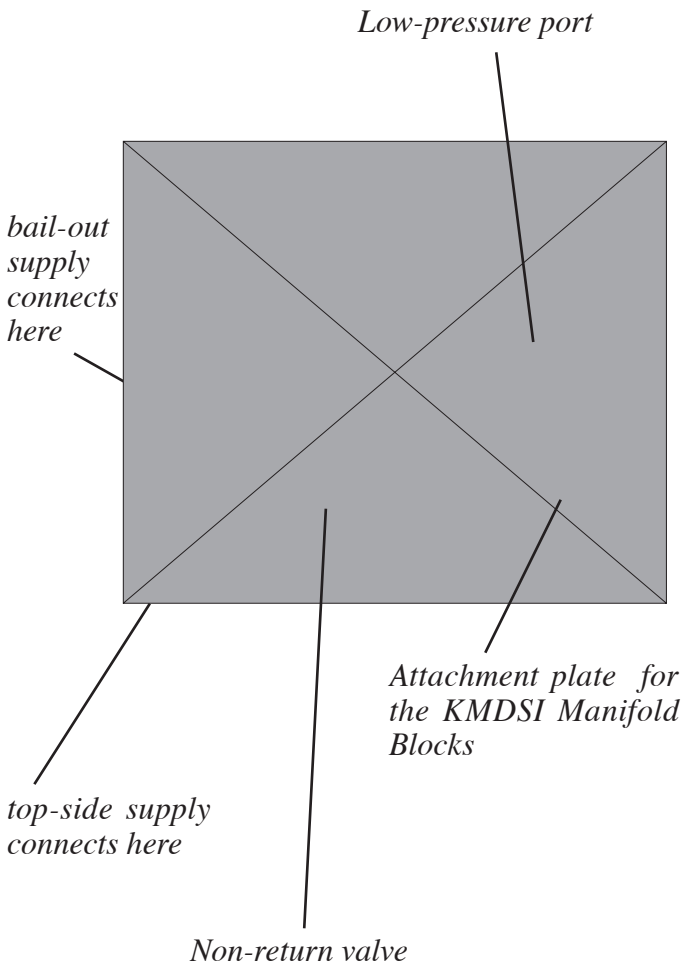

2) Screw the hose from the 1st stage onto the emergency valve on the manifold block assembly. Tighten this fitting.

3) The diver's umbilical should already be connected to the topside dive control system at this time. Remove

the protective cap from the diver's end of the umbilical. Turn the air that supplies the KMACS-5 on.

While holding the open end of the diver's umbilical away from you, slowly turn on the air to the umbilical at the KMACS-5. This action will blow out any water, dust, or other foreign debris which may have entered the dive hose. Allow the air to vent from the hose for at least 15 seconds.

4) Connect the diver's air supply hose on the umbilical to the one way valve on the diver's manifold block assembly. Use the correct size wrenches and always use a back up wrench. Tighten the fitting only until snug. Do not overtighten. If too much force is applied to the fitting it will cause the fittings to deform and leak.

5) Connect the hose that was supplied with the mask or the low-pressure high flow hose to the appropriate low-pressure port on the manifold block, then to the mask. Remember to always use a back up wrench on the nipple tube when attaching the hose to the regulator on the mask.

2.19 Use of Quick-Disconnect

If you are using the mask for surface-supplied diving, the use of a quick-disconnect fitting with a sleeve lock is recommended. The quick-disconnect should be installed on the low-pressure hose that connects the mask to the manifold block. By using this fitting, you can separate the mask from the bail-out system to work on it. The quick disconnect should have locking sleeve to help prevent accidental separation.

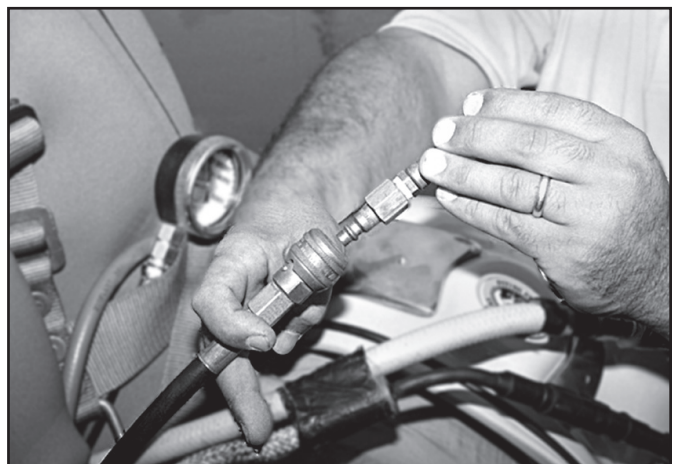

The use of a quick-disconnect fitting makes using the mask much easier for surface-supplied diving.

2.20 Connecting the Umbilical to the Mask

When you connect the hose to the mask be sure to use a wrench to hold the adapter, or inlet fitting, and a second wrench to turn the swivel fitting on the hose. If this is not done, the adapter will turn inside the one way valve. If this happens repeatedly the threads will wear and the valve will need to be replaced.

The connection between the hose and the mask must only be made up “snug”. Excessive force will deform and ruin the adapter. A second wrench must be used when the mask is disconnected as well, otherwise the adapter and/or the one way valve assembly may become loose and fail to make a seal.

If you are using waterproof connectors for your communications, take extra care in handling these pieces. To connect the male and female parts, align the large pin on the male connector with the yellow mark on the female connector. Press the two connectors together until you hear a distinct “pop”. Do not twist the connectors. Tape the two connectors with a bit of electrical tape to prevent them from pulling apart.

To separate the connectors remove the tape, grasp them at the thickest part, place your thumbs against each other, and push apart until the connectors are



Be sure to blow out the umbilical to remove any foreign matter,



WARNING

If the one way valve or the adapter is loosened this will allow breathing gas to leak out of the breathing system. This could also result in a loss of all pressure to the helmet, leaving the diver with nothing to breathe.

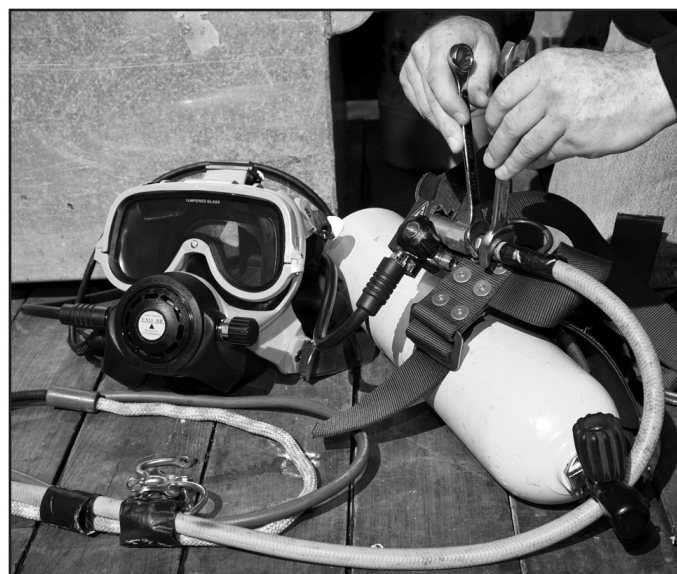

Use two wrenches to connect the umbilical to the bail-out manifold. Do the same with the mask. disconnected.

Do not twist the connectors. Do not pull them apart by pulling on the thin part of the wires.



Connect the waterproof connectors without twisting them.



You can use electrical tape to secure the waterproof connectors together.

2.21 Opening the Breathing Gas Supply to the Mask

Prior to turning on the air supply for the mask, check to see that the free flow valve is closed and the regulator adjustment knob is all the way in.

Slowly bring up the gas pressure to the mask to 150 p.s.i.g. (10.2 bar). Slowly back out on the regulator



Always test the communications before the diver gets in the water.

adjustment knob until a slight free flow develops, then turn the adjustment knob in (clockwise) until the free flow just stops.

To properly check the breathing system you must completely don the helmet.

2.22 Fogging Prevention

A thin film of anti-fogging solution may be applied to the interior of the face port prior to the dive to help prevent fogging during the dive. A mild liquid dish washing detergent, or other commercially available anti-fogging solutions, may be applied with a soft rag or paper towel to the interior of the port.



A thin film of liquid soap will help to keep the lens clear.

2.23 Proper Hood Fit

The type of hood that a diver chooses may have direct bearing on the fit and comfort of the EXO. Excess material on the chin and or jaw will keep the mask from positioning properly and possibly cause jaw fatigue. This may also prevent the diver's face from getting far enough into the mask for equalizing by pinching the nose.

When using a dry suit with a latex hood, no adjustment should be needed. However, if the hood covers too much of your face, it may be necessary to trim a small amount of rubber off the chin on the hood. If using a neoprene wet suit hood, you may want to trim material from the cheek bone downward to under the front part of the chin.

To properly trim your hood, use the following procedure:

- 1) With the hood in position on your head, don the mask as outlined in this chapter.
- 2) Have someone bend the earphone pockets on the mask forward, and start marking the hood with a white china marker at the edge of the face seal, starting at the cheek bone area, then continue down under the chin and up the other side to the opposite cheek bone area.
- 3) Remove the mask and hood. Leave approximately 1/4" extra material from the line marked and trim the excess material away.
- 4) Your hood should now work very well with the mask.



KMDSI offers a neoprene hood, designed for use with the EXO mask in colder waters.

Because the face is in a dry air cavity being warmed by body heat, hood material on the face is not needed to keep the face warm.

KMDSI makes a hood tailored to the EXO (see the accessories section of this manual) It must be trimmed in the same fashion as above. The face seal area is a thinner two-sided "skin" neoprene for a superior seal.

Note:

A small hole can be punched in the top of the hood to relieve any build up of air inside. Put the hole or holes so that they are to either side of the top spider strap.

2.24 Recommendations for Donning and Removing

A course in the procedures for safe diving with a full-face mask should be taken and passed before any type of diving is performed. Practice using the mask in a calm, clear body of water (pool) before using for open water diving.

People with narrow faces may need to use the Face Seal Cushion Kit (Part#325-025) to achieve a good fit with the mask .

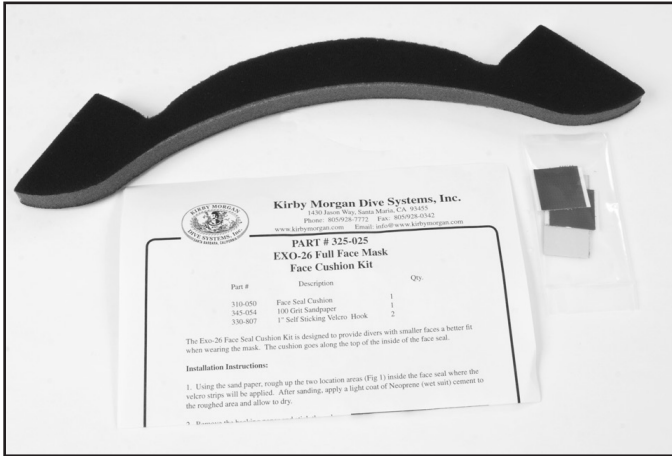

The Face Seal Cushion Kit is a good way to help adjust the fit of the mask for a person with a narrow face.

Become familiar with the way in which the mask attaches and properly fits your face. Because the face seal fits the face well when loosely fitted, it is easy to assume that this is how the mask should be worn. This assumption is incorrect and can cause negative results when diving.

Wearing the mask with an incorrect adjustment will not allow the diver's face to go far enough into the mask. The air space inside the mask will be excessive, causing buoyancy and possible problems with the fit of the seal and oral nasal. The main portion of the face seal is designed to be very flexible and should be stretched to form a proper seal and be comfortable.

The spider (head harness) and buckles are also important for proper function of the face seal. The spider legs and rear head cup are all shaped to pull the mask to the face. The head cup should be placed as low as possible to reduce jaw fatigue.

The buckles swivel (all except the top buckle) to allow the spider to find its natural correct position. Do not try to force the buckles to swivel completely around.

WARNING

The tender must always be present to assist the diver while dressing and whenever the diver has his mask on his face while he is out of the water. It is difficult for the diver to walk while he is dressed in and he can stumble and fall, resulting in serious personal injury.

They are allowed free but limited movement to keep the spider from becoming entangled while the mask is being handled.

2.25 Donning the EXO Mask

1) Make sure that all other gear is properly donned, the air is on, and regulator functions and communications tests have been done.

2) Make sure all 5 legs of the spider are loosened all the way.

3) While holding the mask in position by the chin cup, begin tightening the spider at the bottom straps, but not all the way.

4) Make sure the cup of the spider is positioned on the center of the back of your head. It should be low, but not as low as your neck.

5) Next tighten the top two straps above the temples. Alternate between top and bottom straps until the face is positioned properly and snugly into the mask.

The mask is usually the most comfortable when your nose is partially into the nose pocket. The top center strap can be tightened slightly to give support to the mask while standing by for water entry. Once in the water this top strap may be loosened.

Sometimes, if the top strap is too tight and the diver's hood fills with air while diving, the hood pushing against the top strap may cause the mask to lift up on the face. The spider may be readjusted during a dive.

6) A tender should always be available to assist the diver to ensure that his mask is donned correctly, his hoses are routed properly, and to help ensure he does not fall while walking around on deck.

7) If you are using the EXO hard shell, the special bracket must be installed prior to donning. The hard shell is donned after the mask has been donned.

It is the tender's responsibility to tend the diver's hose and to assist him into and out of the water.



WARNING

Do not dive this mask in water containing concentrations of petroleum based chemicals. This can cause the mask frame to fail, causing the mask to flood, leading to drowning.



Tighten the lower spider legs first.



Tighten the upper spider legs next.



If you are using the EXO hard shell (part #300-010), the special bracket must be installed prior to donning. The hard shell is donned after the mask has been donned.

2.26 Removal of the EXO Mask

Removal of the mask is quick and easy.

- 1) Grasp the bottom of the mask on each side where the buckles are attached.
- 2) With your thumbs, push the tabs on the buckles all the way forward. They will stop traveling once they hit the buckle caps. Hold the buckles forward.
- 3) At this point, push the bottom portion of the mask away from the face as if it were hinged to your forehead. This will release the bottom legs of the spider and allow quick and easy removal of the mask.



The EXO is easily removed by the diver when necessary.

Chapter 3

Diving With The EXO Full-Face Mask

3.1 Introduction

This section deals with the different functions and adjustments that are possible after entry into the water. Some divers may be satisfied with the fit and function of the mask as it is set up topside, or it may be easily adjusted in the water if necessary.

3.2 Water Entry

Many methods of entry into the water are possible using the EXO-26 or EXO-BR, but a few important points should be noted. When using the stride entry, the bottom holes in the exhaust whisker should be covered to prevent any turbulent water from flowing past the exhaust valve.

The demand regulator adjustment also serves another important function, in the unlikely event the mask should develop a continuous water leak, the diver can back out on the demand regulator adjustment knob until the regulator develops a free-flow of gas. The free-flow of gas will displace any incoming water. The diver then can abort the dive with both hands free.

If you roll into the water backwards, turn your head to one side before entering to prevent water from washing past the face seal to the interior of the mask. In the event water does enter the mask, keep the regulator positioned low and simply press the purge button to remove the water.



WARNING

Do not dive this mask in water containing concentrations of petroleum based chemicals. This can cause the mask frame to fail, causing the mask to flood, leading to drowning.



The regulator adjustment should always be set for the maximum ease of breathing.

3.3 Regulator Adjustment

The regulator adjustment knob should always be adjusted for minimum breathing resistance. Prior to entering the water, adjust the regulator adjustment knob out until a slight free flow develops and then adjust it in until the free-flow disappears. If diving with scuba gear no further adjustment should be needed.

If you're diving with surface-supplied gear, the adjustment knob allows the diver to make adjustments for variations in supply pressures. During the course of the dive the diver should periodically turn the adjustment knob out (counter clockwise) until the regulator develops a slight free-flow, then turn the knob in (clockwise) until the regulator free-flow just stops. This will ensure the diver is always taking advantage of the best performance for the available delivery pressure. The regulator adjustment knob can also be used to compensate when working in various positions and diving in currents.

The most noticeable difference in breathing resistance can be found in a face up position. Resistance increases with the regulator diaphragm in this position.

If the regulator adjustment knob is adjusted all the way in and breathing resistance is high, it is sometimes possible for small amounts of water to get past some areas of the face seal when the mask is not fitted properly. Any leakage which does occur usually enters in the temple area.

Backing out on the adjustment knob will decrease the spring bias tension on the roller lever, allowing the diaphragm to move the roller lever with less inhalation effort. This will help prevent water from being drawn in around the face seal. If leakage still persists, a face cushion kit is recommended.

Fine tuning the regulator should be common practice if you maintain a certain position for any length of time and then change positions. If you are working in a face down position and the regulator adjustment knob is adjusted too far out, the regulator may free-flow. The adjustment knob should be turned in to stop any excess air flow.

3.4 Spider Adjustment

The mask can be repositioned while in the water, by loosening, repositioning and retightening the spider legs. The large tabs on each buckle provide this easy adjustment. It should also be noted that the buckle travel is limited to allow easy release.

The top leg of the spider can be loosened once in water. It is possible for the top leg to be too tight which will cause the mask to be pulled up too far on the face. The main purpose for the top leg of the spider is to provide on deck support of the mask. Some divers may prefer the support of the top leg while in the water, too.



The mask is easily adjusted underwater.



CAUTION

Proper hood fit and spider adjustments are needed for the mask to fit comfortably and function correctly.

3.5 Purging the Mask

If the mask is removed and then replaced underwater, it must be cleared of water (purged). This is done by simply holding the mask firmly on the face, keeping the regulator in a low position, and depressing the purge button. A momentary slight overpressure will be felt, followed by complete removal of all water from the interior of the mask. A mask completely filled with water should take no more than 3 seconds to completely purge.

In the unlikely event the mask should develop a continuous leak, the diver should maintain a face forward and

slightly down position, and slowly turn out (counterclockwise) on the demand regulator adjustment knob until a steady free-flow of gas develops. The free-flowing gas will displace the water and keep the mask cavity clear.

The diver should then immediately notify topside (if equipped with communications) and abort the dive.



Using the purge button to clear a flooded mask.

! WARNING

In the unlikely event the mask should fill with water, depressing the purge button should clear the mask. In the event of a continuing flood, the adjustment knob should be turned out to cause a regulator free-flow. The diver should then immediately assume a face down position in the water to prevent the mask from flooding again. At this point the diver should exit the water immediately.

3.6 Procedures to Follow for Loss of Breathing Gas

SCUBA

When diving scuba with a full-face mask it is essential that the scuba regulator is equipped with an accurate submersible pressure gauge. If the gas supply is exhausted, there are no provisions for buddy breathing with the mask on the face.

If the regulator starts breathing hard or quits breathing, check the air supply. If the gauge indicates air pressure in the cylinder, back out on the demand regulator adjustment knob until a free-flow is established and abort the dive. If there is no air in the cylinder, immediately abort the dive.

Surface-Supplied Mode

If surface-supply gas is interrupted or fails, the diver should immediately open the emergency valve on the manifold assembly. If gas is still not restored, the diver should back out on the demand regulator adjustment knob (counterclockwise) to establish a steady flow, notify topside, and abort the dive.

Regardless of the cause, whenever a supply of gas fails even if it is restored the diver should abort the dive and the problem should be thoroughly investigate as to the cause of the failure. Diving should only proceed after all problems are rectified.

! WARNING

If using scuba, use of a steady flow will rapidly deplete the scuba cylinder. Adjust the free-flow so that the flow of gas needed to keep the water out is minimal. Continuous leakage of water into the mask is not normal. Do not continue a dive if continuous water leakage is present.

! DANGER

Rapid ascent is dangerous. It can lead to air embolism or decompression sickness. Air/gas embolism can cause immediate loss of consciousness and/or death. Even on a no decompression dive, a rapid ascent may cause decompression sickness. A diver must only make a rapid ascent when he is in immediate danger of death by drowning, asphyxiation, or some other cause.

! DANGER

Ditching the mask underwater must be avoided. If the diver ditches the mask underwater he will not be able to see.

In many instances, if you are diving in the surface-supplied mode, even if the air supply is interrupted, topside will be able to get it back on line quickly. Do not ditch the mask underwater unless you are completely out of breathing gas and it is impossible to return to the surface due to entanglement of your equipment or similar circumstances.

Chapter 4

Post Dive Procedures And General Maintenance

4.1 Introduction

This section covers the preventative maintenance necessary on the EXO Full-Face Mask. A mask that is kept clean and in good repair will offer far better service to the user. These masks are designed for easy access to all areas for proper inspection and servicing.

4.2 Required tools, Sealing, Cleaning Agents, Lubrication

All KMDSI helmets and masks are designed with the professional diver in mind. Most maintenance can be performed by the diver using common tools and this manual. There are some repairs however, that must be accomplished only by KMDSI authorized repair facilities. This includes fiberglass and helmet neck ring repairs, face port inserts and sealed pin overhauls. For technical assistance please telephone your nearest authorized dealer or call KMDSI at (805) 928-7772.

Every diver should carry sufficient tools and spare parts to maintain his mask in top working condition. It is very important to use wrenches of the correct size rather than adjustable wrenches when possible. Adjustable wrenches tend to slip and can round the edges of soft brass parts.



Special tools are required to do proper maintenance on the EXO mask.

4.3 Component and Parts Cleaning

The mask and components should only be cleaned using a mild solution of dish washing soap such as JOY™ or Dawn™ hand dish washing soap.

Parts that have corrosion should be washed and scrubbed with a nylon bristle brush and then soaked in a solution of 50% white vinegar and water for 30-60 minutes followed by a light brushing and a good fresh water rinse. Rubber components should be cleaned using a mild soapy solution followed by a good rinsing and air-dried.



Ordinary dish soap is acceptable for cleaning.

DO NOT use hair dryers or high heat to dry the rubber components, high temperatures will severely reduce their serviceability. To clean parts heavily encrusted with salt we recommend a dilute solution of white vinegar and a toothbrush.

4.3.1 Component and Parts Lubrication

All masks are lubricated at KMDSI with ChristoLube. Masks used for air diving or diving or with oxygen mixtures containing less than 50 % oxygen can be lubricated with food grade silicone such as Dow corning 111 or equivalent. ChristoLube is the preferred lubricant.

Do not use aerosol spray or lubricants. Many aerosol propellants will damage plastic. Avoid lubricant contact with plastic parts.

! WARNING



Do not use any type of chemical locking solutions, such as Loctite®, on this mask. They can attack and severely damage the mask frame. This can cause the frame to fail unexpectedly, causing flooding of the mask and drowning.

4.4 Disconnecting the Mask from the Diving System

To disconnect the mask from the surface-supplied system:

1) Disconnect the mask from the diving hose and EGS cylinder. Make sure the air is off and the breathing system of the mask is unpressurized. To vent the system, open the bail-out valve on the manifold block on the diver's harness and push the purge button on the mask.

2) If you have a quick-disconnect fitting on the low-pressure hose between the mask and manifold block, you can separate the mask here. Otherwise, you will need to disconnect the low-pressure hose from the manifold block once the air has been vented.

To disconnect the mask when used in the scuba mode:

1) Turn off the scuba cylinder at the valve.

2) Depress the purge button on the mask until all air is vented from the first stage regulator, hose, and second stage in the mask.

3) Disconnect the first stage from the scuba cylinder and cap the high-pressure inlet filter on the regulator.

! WARNING

Never disconnect any hose from the mask unless all gas has been vented from the hose first. If the hose is disconnected with pressure in the line the fittings may be damaged. In addition, the hose can whip about causing injury to anyone standing nearby.

! WARNING

Different brands of grease should never be mixed. Ensure all old grease is removed prior to applying new grease.

4.5 Daily Maintenance

The mask should be rinsed thoroughly with fresh clean water and the post dive procedures followed after each day of diving. Cleaning is usually performed after the mask has been disconnected from the air supply.

1) Wash the exterior of the mask with a mild soapy water solution and rinse thoroughly with fresh water.

Do not depress the purge button while rinsing the regulator as this action will permit foreign matter back into the inlet valve and seat.

2) Remove the regulator cover ring, regulator cover, washer and diaphragm, then clean all components and swab out the interior of the regulator with the sanitizing solution as per the sanitizing procedure. Note: avoid depressing the purge button to minimize water entering the inlet valve.

After cleaning and sanitizing, rinse thoroughly.

3) Screw the demand regulator adjustment knob all the way out. This will prolong the life of the inlet valve and keep the internal adjustment correct.

4) Remove the earphones from the earphone pockets. Remove the earphone covers from the earphones so they can dry completely. Clean the microphone with sanitizing solution, rinse it, and allow it to dry.

5) Allow the entire mask to dry in a cool, dry location prior to storage.

6) Lay the mask face down so that no water will collect in the ear pockets. DO NOT dry the mask or let it sit in the direct sun light for long periods of time, as this will degrade the rubber.

7) For additional details on daily maintenance, consult the Dive Lab website at www.divelab.com



The regulator adjustment knob should be backed all the way out for storage.



Uncover the earphones so they may dry.



WARNING

Use only mild hand dish washing soap and water to clean this mask. Do not use any solvents or petroleum based chemicals. These may damage the mask frame, leading to failure, flooding of the mask, and drowning.

! WARNING

If in doubt about the serviceability of a part, repair or replace it immediately. Use only Genuine Kirby Morgan replacement parts. The use of unauthorized parts may result in injury or death to the user.

! WARNING

Do not use solvents or bleach for cleaning. These agents are toxic and use of them may result in injury or death to personnel and damage to equipment.

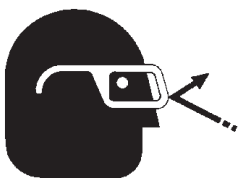
! WARNING

Wear eye protection to prevent cleaning and germicidal cleansing solutions from contacting eyes. If contact occurs, rinse eyes with

copious amounts of water and consult medical help immediately.

! WARNING

Cleanliness is imperative in maintaining and handling Kirby Morgan masks and helmets. All tools, parts, and components must be kept free of oil, grease, rust, and other contamination. Foreign substances within an assembly may result in equipment failure and possible injury or death to personnel.

4.6 Inspection Procedures

Each diver must establish his own minimum standards for the care of his mask. We offer recommendations here with the suggestion that the diver establish for himself what is necessary to provide a good working unit. Use of the mask in fresh water will require a timetable for maintenance procedures different from that when the mask is used in salt water.

Using the mask in sea water while jetting in sand will necessitate increased maintenance. Use of the mask in a heavy oil and/or chemical environment may make it necessary to replace rubber parts to assure proper function. Regardless, all diving helmets and masks should be disassembled, cleaned and inspected at least once a year. All soft goods should be replaced at least once a year, if needed.

NOTE: Certain fuel oils and/or chemicals will cause premature degradation of soft goods and seals by making them become soft, swell or break down. Upon exiting the contaminant, KMDSI recommends a thorough external decontamination/washing of the mask as soon as feasibly possible, followed by a vigilant inspection of the interior of the mask to ensure that no contaminant has entered.

Pay particular attention to the following parts prior to re-use; the regulator assembly, demand regulator diaphragm, demand regulator exhaust valve, and communications connector assembly.

O-Ring Removal/Inspection/Cleaning and Lubrication

Strict cleanliness and proper lubrication are extremely important during O-ring installation. Comply with the following instructions to ensure proper installation:

NOTE: Ensure all parts are clean throughout the assembly procedure. Dirt or loose particles in the O-ring groove can cause leaks in the seal and damage to the O-ring, reducing its life. During cleaning of equipment, carefully clean O-ring grooves, using a soft bristle brush and mild soap solution.

O-Ring Removal:

Do not use screwdrivers or hard metal picks to remove o-rings. When possible, only use fingers to remove o-rings. If an o-ring fits too tightly in its groove to be removed using the fingers, use the appropriate tool such as a brass pick (or a wooden toothpick).

A plastic cable tie makes an effective o-Ring removal tool. Use of an appropriate tool helps prevent scratching the o-ring groove, which can cause leakage or premature failure of the seal.

O-Ring Inspection:

If during routine corrective maintenance o-rings are to be reused, only reuse o-rings that pass a visual inspection. Inspect for deformities or compression set, hardening or brittleness, nicks or cuts, pits or blisters, or any other signs of damage. Cut and discard damaged o-rings and replace them with new ones.

O-Ring Reuse:

All o-rings and soft goods should be replaced whenever scheduled overhauls are being completed. During routine repairs or maintenance in between the overhauls, o-rings and soft goods may be reused after cleaning provided a careful inspection reveals no wear or damage.

Place the o-rings in a cleaning basin, cover with mild soap solution, and brush gently with a soft bristle brush to remove all traces of old lubricant and contamination.

Rinse cleaned o-rings with fresh water and wipe clean with lint-free cloths, then allow to air dry, carefully inspect for cracking, cuts, abrasions and deformities. Replace o-rings if any damage is found or suspected.

4.7 General Cleaning Guidelines



Cleaning and sanitizing of the mask should be accomplished upon completion of use and/or prior to storage. Clean is defined as free of dirt, rust particles, grease and oil and other contaminants as viewed by the unaided eye.

Sanitizing is defined as eliminating germs and microorganisms. Sanitizing should be accomplished post use or prior to use by another user. KMDSI recommends sanitizing be accomplished any time the unit is to be used by another person during the mission or operation.

NOTE: *The Sanitizing Procedure should be accomplished if possible between dives when two or more divers are making consecutive dives with the same mask.*

Both the regulator cover and diaphragm should be removed for cleaning and sanitizing. The inside of the regulator and whisker must also be sanitized. Read this manual completely for instructions on how to remove and replace these components properly.

See the most up-to-date procedures for cleaning on the Dive Lab website at www.divelab.com.

	WARNING
	<p>Always sanitize the mask prior to use by another person. Failure to do could result in the transmission of communicable diseases, some of which may cause long term disability or death.</p>

4.7.1 Mild Soap Solution for General Cleaning and Leak Detector Use

Maintenance procedures include cleaning with a general-purpose solution of a mild diluted hand dish washing soap such as Joy® or Palmolive®. Cleaning solution is prepared by mixing approximately one teaspoon of soap to 1/2 gallon of warm fresh water. This solution may also be used as a leak detector solution. Place all parts and components in a clean washbasin or sink and immerse in soap solution.

Allow parts/components to soak for at least five minutes, and then scrub using a nylon brush. Carefully brush all surfaces, paying close attention to O-ring grooves and threaded surfaces ensuring all greases are removed. Regardless of the soap used, all components must be thoroughly rinsed post cleaning to remove all traces of soap.

4.7.2 Acidic Cleaning Solution and Procedures

Metal parts that have visible corrosion should first be cleaned using the soap solution scrubbed with a nylon bristle brush, then soaked in a solution of 50% white vinegar and water for less than 60 minutes. They may also be placed in a ultrasonic sink followed by a light brushing and thorough rinsing with fresh water and air-dried. If corrosion is such that 50/50 vinegar will not clean components, it is best to replace the components.

4.7.3 Germicidal Cleaning Solutions and Procedure

Sanitizing of the oral-nasal mask/regulator of Kirby Morgan masks is accomplished using one of four approved germicidal cleansing solutions. There are four examples of solutions shown here, along with the necessary ordering information and mixing instructions.

NOTE: *Ensure optional face cushion is removed prior to sanitizing the oral-nasal mask/regulator.*

1. **SaniZide Plus:** P/N: 34805 (spray) or 34810 (gallon), Ready to use; do not dilute.
SAFETEC of America, Inc
1055 E. Delavan Ave.
Buffalo, NY 14215 USA
1-800-456-7077

2. Advance TBE: P/N: AD160 (spray) or AD1128 (gallon), Infection Control Technology): Ready to use.

Infection Control Technology
1751 So. Redwood Rd.
Woodscross, UT 84087 USA
1-800-551-0735

3. Bi-Arrest 2: P/N: BP201 (4 ounces) or BP 222 (32 ounces), Infection Control Technology. Mix two pumps of the concentrate with 16 ounces of fresh water.

Infection Control Technology
1751 So. Redwood Rd.
Woodscross, UT 84087 USA
1-800-551-0735

4. Confidence Plus: P/N: 10009971 (32 ounces) Mix one ounce of concentrate with one gallon of fresh water.

Mine Safety Appliances 1-800-MSA-2222

Sanitizing Procedure:

Unless otherwise directed, use the following procedure to disinfect the oral-nasal mask/regulator:

- 1) Wet or immerse all components to be sanitized. Allow components to stay in contact with the solution for at least 10 minutes.
- 2) If the solution appears to be drying, apply more solution to keep it wet for the full 10 minutes.
- 3) After 10 minutes, thoroughly rinse components under running potable water.

NOTE: *The purpose of this procedure is to sanitize the components exposed to each of the divers. KMDSI recommends sanitizing be accomplished daily in between use by different divers, after each use, or when future use is anticipated within the mission (job) period. KMDSI defines “A mission is defined as use of the mask over a seven-day period.”*

CAUTION

Germicidal cleansing solutions must be carefully diluted if required in accordance with the manufacturer's recommendation. If solution is not of the recommended strength, it will not act as an effective disinfectant. Failure to thoroughly rinse germicidal cleansing solution from diving equipment may result in lung irritation and/or long-term degradation of rubber and silicone components of this equipment.

WARNING

Do not use solvents or bleach for cleaning. These agents are toxic and use of them may result in injury or death to personnel and damage to equipment.

WARNING

Cleanliness is imperative in maintaining and handling the Kirby Morgan masks and helmets. All tools, parts, and components must be kept free of oil, grease, rust, and other contamination. Foreign substances within an assembly may result in equipment failure and possible injury or death to personnel.

WARNING

Use only mild hand dish washing soap and water to clean this mask. Do not use any solvents or petroleum based chemicals. These may damage the mask frame, leading to failure, flooding of the mask, and drowning.

4.8 Communications Inspection

Visually inspect the earphones, microphone, wires, lugs, and communications posts if installed. Test each component for proper operation. Connect to the deck amplifier and talk back and forth. Replace any weak earphone or microphone. Open the earphone rubber covers and remove the protectors. Allow to dry thoroughly. Replace defective earphones.



Regularly inspect and test the communications components.

4.9 Reassembling the Mask After Cleaning

Ensure that all the parts and assemblies are completely dry before assembling or storing.

- 1) Install the oral nasal and equalizer if they were removed.
- 2) If so equipped, install the communications in accordance with this manual. If no communications are used, the hole in the microphone cup in the oral nasal must be plugged. Use KMDSI oral nasal microphone plug, part # 320-001.
- 3) When storing the mask, make sure the regulator adjustment knob is backed all the way out. This will prevent wear to the regulator seat and lengthen its useful life. Store the mask with the earphone pockets facing straight back or inward. This will help the rubber keep its shape better than stored with the earphone pockets facing outward.

All the O-rings should be replaced at least once a year. The inlet valve on the EXO Standard and Original should also be replaced once a year. The EXO BR inlet valve will not require annual replacement as long as it is routinely cleaned and lubricated and there is no evidence of corrosion or damage.

All the EXO masks were designed for minimal maintenance. It is important to carefully inspect the mask after post dive maintenance to ensure it has been properly cleaned and dried prior to storage.

Your entire regulator should be rebuilt every year. To perform an entire regulator rebuild (including the exhaust valve) or to replace the face seal, the regulator mounting tools must be purchased.



WARNING

All parts on Kirby Morgan masks and helmets must be adjusted to their proper torque specifications. See Appendix 1 for a complete listing of torque specifications for each part. Failure to adjust parts to the recommended specifications could lead to helmet failure and accidents. This could be fatal.



WARNING

Different brands of grease should never be mixed. Ensure all old grease is removed prior to applying new grease.

Chapter 5

EXO Regulator Maintenance

5.1 General Information

All EXO demand regulators are initially adjusted and preset at the KMDSI factory using an intermediate pressure of 135-150 p.s.i. The EXO regulator is an adjustable second stage regulator. This allows the masks to work well over a wide range of pressures and diving conditions.

When regulator parts need changing, cleaning, or the regulator has gone out of adjustment, **read all of the following and refer to the diagrams and blowaparts to become familiar with all parts and terms associated with the areas of the mask** prior to any disassembly of the regulator. There are two types of EXO regulator covered in this manual, the EXO original/standard and the EXO-BR (balanced regulator), with disassembly and rebuild sections for each.

The EXO Standard and Original masks should be overhauled every year. This includes O-ring and inlet valve replacement. The EXO-BR demand regulator should be disassembled, cleaned, and inspected every six months.

The inlet valve on the EXO-BR normally sees very little wear, so replacement is only needed after every twenty-four months. Because the EXO-BR inlet valve is of a pneumatically balanced design, the EXO-BR demand regulator inlet valve requires more frequent cleaning and lubrication than the EXO Standard and Original. The inlet valve should be removed and both the inlet valve and the main tube should be cleaned and inspected every six months.

After cleaning and inspecting the inlet valve, the balance O-ring should be lubricated. This procedure can be complete with out removing the demand regulator assembly. Normal overhaul does require replacement of all regulator O-rings.

Normal annual overhauls of the EXO demand regulators **DO NOT** require you to completely remove the regulator can body from the mask. Removing and reinstalling

the regulator is a difficult procedure, and will require the KMDSI regulator mount nut tool. Complete mask disassembly is possible provide the user has the proper KMDSI tools. However, it is recommended that this service be performed by a factory trained KMDSI Dealer. **Contact KMDSI at (805) 928-7772 for your nearest factory trained service center.**

Note: If you are doing a regulator rebuild and **are changing the exhaust valve**, it is possible to do a replacement without completely removing the regulator. Follow the directions for disassembly of the regulator. Then follow the directions for removing the regulator, but instead of taking the regulator mount nut completely off, only loosen it enough for the regulator to be pulled slightly forward, then pull the whisker off of the regulator body to access the exhaust valve.

Replace the exhaust valve making sure that it is facing the right direction and seated correctly. Then put the exhaust whisker back on and follow the directions for installing the regulator. Following this procedure saves you from having to remount the regulator in the mask seal and frame and from possible cross threading of the regulator body while putting the regulator mount nut back on.

5.1.1 Special Regulator Tools

There are two special tools that will assist you in maintaining your EXO regulator. They are as follows:
KMDSI Part #325-620 Spanner wrench
KMDSI Part #325-625 Back-up wrench

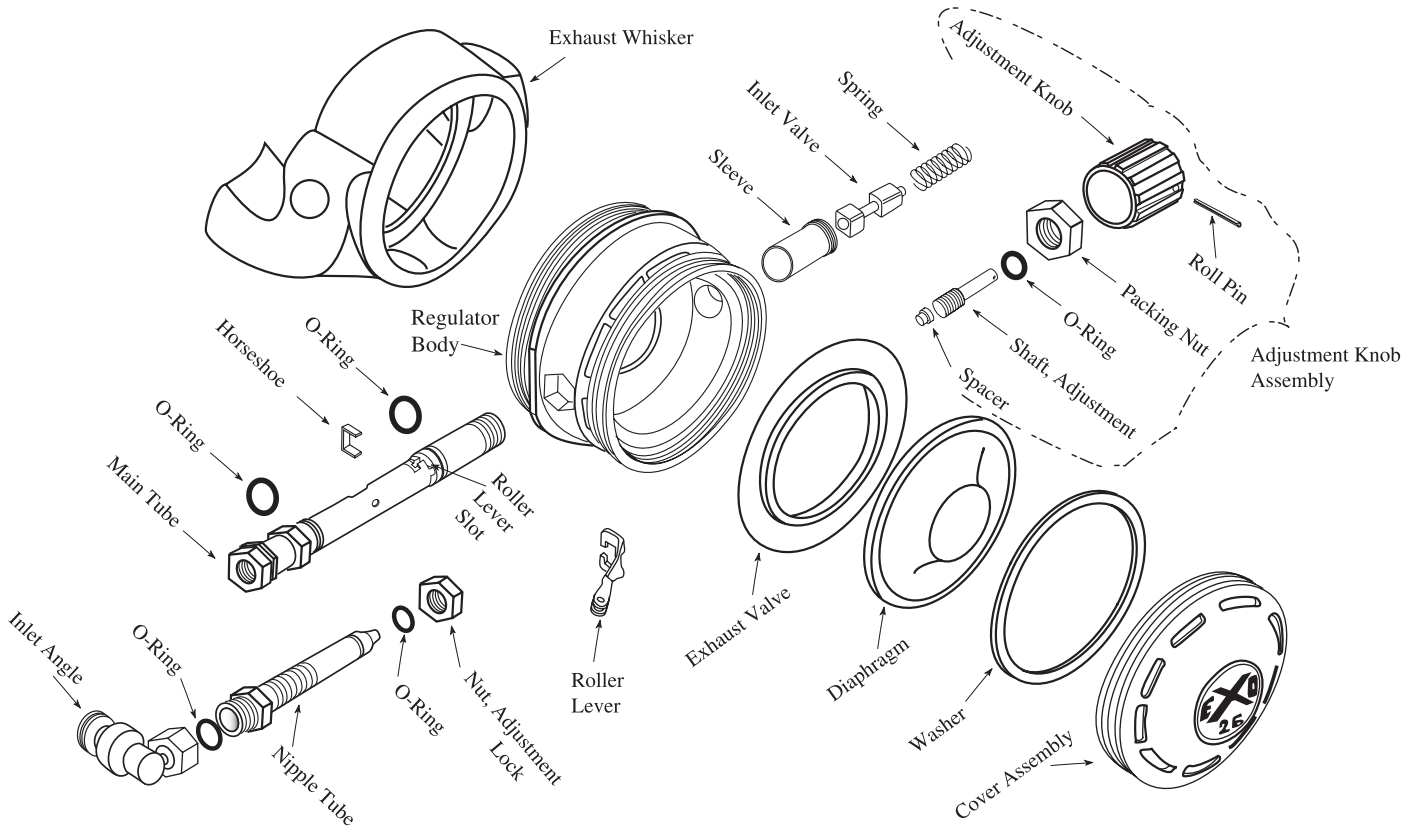

The EXO Original and Standard regulator

CAUTION
 Use only Kirby Morgan original replacement parts when repairing your mask. The use of other manufacturer's parts will interfere with the performance characteristics of your equipment and may jeopardize your safety. Additionally, any substitutions will void any warranties offered by KMDSI. All of the spare parts listed on the blowpart drawings were specifically manufactured by KMDSI for use on the EXO. When ordering spares, always insist on KMDSI original parts.

5.2 Original and Standard EXO Regulator Disassembly

Tools required:

13/16" open end wrench, 5/8" open end wrench

IMPORTANT NOTE: This section is for the EXO original and standard regulators which are no longer produced. If you have the EXO BR, follow the procedures for that system covered later in this chapter.

1) Unscrew the regulator cover assembly and remove



Always use a back up wrench on the main tube when loosening the packing nut to prevent possible damage to the regulator.



The adjustment assembly is removed after the packing nut is loosened.



*Remove the spring and spacers.
the washer and diaphragm.*

2) Back out the adjustment knob far enough to allow a 13/16" open end wrench to fit onto the packing nut. Place a 5/8" open end wrench, or the wrench provided with the mask, on the opposite side of the main tube. This will be used as a back up wrench to keep the main tube from spinning when loosening the packing nut. Loosen the packing nut and unscrew the adjustment

knob assembly from the regulator.

3) Position the mask so that the adjustment knob end is pointed down and shake out the spring and spacer.

4) Push the adjustment side of the main tube about 3/8" into the regulator body. This will be enough to allow the roller lever to be removed from its slot. Remove the roller lever.

5) Once again position the adjustment knob end of the main tube downward and gently shake the mask to



Push the main tube out enough to allow the lever arm to be removed.



Remove the roller lever arm.

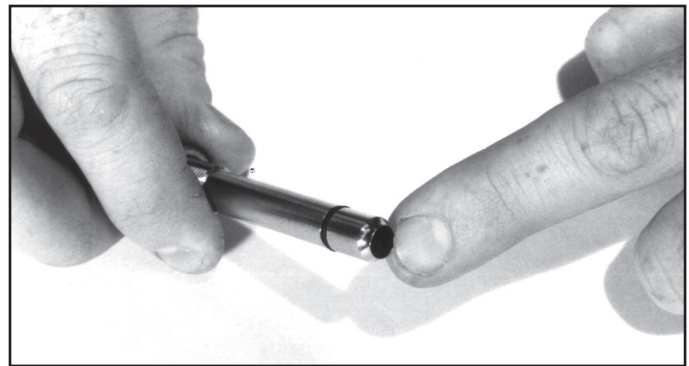

Inspect the nipple tube seating surface for dings, nicks, and wear. You should be able to feel any irregularities with your fingernail.

Gently shake out the inlet valve.

dislodge the inlet valve. Remove the inlet valve.

6) Keep pushing the main tube through the regulator body until the horseshoe is centered in the regulator body. Remove the horseshoe from the main tube by sliding it off.

7) Remove the main tube by continuing to push it through the regulator body

8) Loosen the adjustment lock nut on the nipple tube and unscrew the nipple tube from the main tube.

Inspect the nipple tube seating surface for dings, nicks, and wear. You should be able to feel any irregularities with your fingernail. If the tube is damaged it must be replaced.

9) Inspect and clean all parts. All the O-rings should be replaced at least once a year. Lubricate all O-rings lightly with silicone grease. Inspect the seat on the inlet valve. There should be no cuts or nicks in the seat. Replace inlet valve if seat is damaged.

5.3 Original and Standard EXO Rebuild

After all parts have been cleaned, inspected, and lubricated lightly with silicone grease as needed, make sure all O-rings are in their appropriate places.

1) Install the nipple tube into the main tube. Make sure the adjustment locknut is on the nipple tube before screwing it in. Screw the nipple tube all the way in then back it out about 1/8". Snug the lock nut up against the main tube.

2) Slide the main tube into the regulator body. The main tube should be oriented so that the air inlet hole (the big one in the middle) will be facing up towards the diaphragm. This position will make the horseshoe easier to install. Keep sliding the tube in until the horseshoe area of the main tube is centered in the regulator body.

3) Slide the horseshoe into its place on the main tube from inside the mask. Now rotate the main tube to orient the air inlet hole to face towards the inside of the mask (180 degrees).

4) Keep pushing the main tube in until it is about 3/4 of the way in.

5) Reinstall the inlet valve, rubber seat first, into the adjustment knob end of the main tube. Tilt the mask and gently shake it until the skinny part of the inlet valve is aligned with the roller lever slot in the main tube.

6) Install the roller lever and push the main tube the rest of the way through. Make sure that the roller lever is caught in the skinny area of the inlet valve. Make sure that the exhaust whisker is properly seated on the main tube

7) Reinstall the spring and spacer, spring first, into the main tube.

8) Reinstall the adjustment knob assembly and tighten the packing nut. Remember to use a back up wrench on the other end of the main tube when tightening the packing nut to prevent the main tube from spinning. Tighten packing nut to 40 inch pounds of torque.

Note: If the knob is out too far when tightening the packing nut, the nut will not seal or tighten completely.

9) Make sure the lock nut is threaded all the way on the nipple tube. Screw the nipple tube in until you see the roller lever arm just move, and then stop. Lock the



Make sure the exhaust whisker is properly seated on the main tube.

nut down against the main tube and put the diaphragm and washer with cover back on.

10) Replace the diaphragm washer and screw in the regulator cover assembly and follow the Regulator Adjustment procedures in this chapter.

! CAUTION

Pre-1998 EXO masks used an aluminum inlet valve. If you are overhauling a mask and find one of these aluminum valves we recommend replacing it with a new plastic inlet valve.

5.4 EXO Balanced Regulator Disassembly

Tools required:

11/16" open end wrench

5/8" KMDSI back up wrench.

All plastic or brass handled tube brush

Nylon tooth brush

The inlet valve of the EXO-BR requires frequent cleaning and lubrication due to the exacting tolerances of the inlet valve mechanism. Once familiar with this procedure the task can be accomplished in about 10-15 minutes.

A few words of CAUTION! Use only mild soap such as hand dish washing soap. Use only a tube brush that is all plastic, or does not have an exposed metal tip.. A tube brush with hard metal components could scratch the chrome surface of the balance chamber. If O-rings are to be removed, use only a plastic pick or toothpick. Use of a metal pick could scratch delicate surfaces.

1. With mask disconnected from a pressure source, remove the hose from the nipple tube. If the nipple tube is equipped with the swivel remove the swivel from the nipple tube.
2. Unscrew and remove the regulator diaphragm cover, then remove the thrust washer and diaphragm.
3. Back out the regulator adjustment knob far enough to allow the 11/16" open end wrench to fit on to the packing nut. Place the 5/8" KMDSI wrench on the hex on the opposite end of the main tube, then loosen the packing nut and remove the regulator adjustment knob. Shake the mask, and allow the spring and two spring spacers to drop free.



Remove the regulator cover.

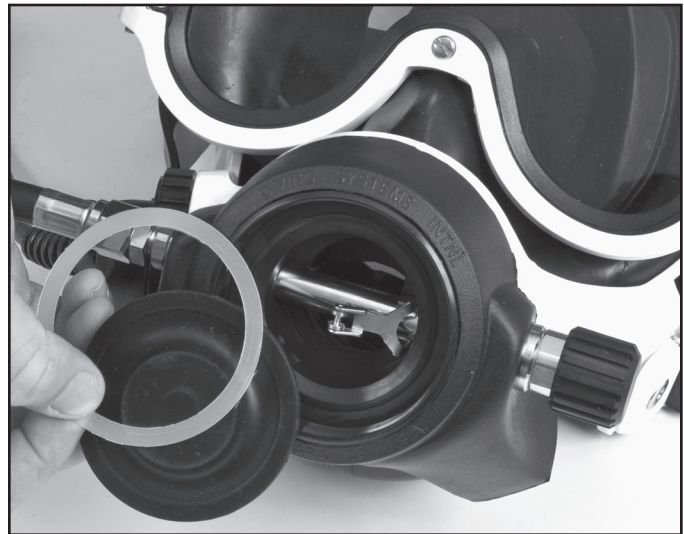

Remove the diaphragm and washer.



Always use a back-up wrench for removal of the adjustment knob assembly.



Unscrew the adjustment knob assembly from the regulator.

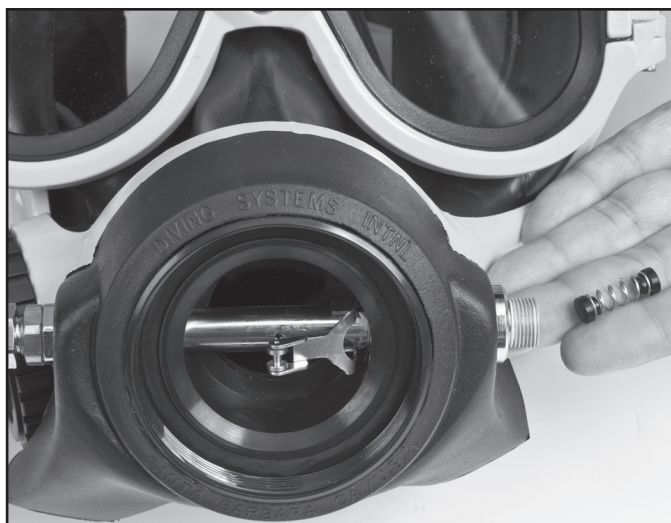

Remove the spring and spacers.

4. Using the thin 5/8 KMDSI wrench on the main tube body and a standard 5/8" wrench on the nipple tube jam nut, loosen the jam nut. Carefully unscrew and remove the nipple tube from the main tube. Be careful not to drop or bump it as the seating surface is very delicate and can be easily damaged. Set it aside where it will not be damaged.

5. Carefully push the adjustment knob side of the inlet tube into the regulator body approximately 1/4" to 3/8". This will allow the lever arm to be removed. After removal, push the main tube the same direction to locate the horseshoe clip at the center of the regulator. Rotate the main tube 180 degrees and remove the horseshoe clip.

6. Shake out the inlet valve, it will drop through the inlet nipple side of the tube. At this point the cleaning and maintenance can be performed without further disassembly, However, should you desire, the tube can be taken out completely.

7. Mix a solution of mild hand dish washing soap and warm water. Using the tube brush, carefully clean the balance chamber located approximately 1 1/2" in from the center of the main tube in the direction of the regulator adjustment knob end. The balance chamber is machined to exacting tolerances and only requires a gentle brushing. **USE EXTREME CAUTION WHEN CLEANING THE BALANCE CHAMBER.** A brush with hard metal components could damage the balance chamber.

8. If the main tube was removed, clean the tube using the toothbrush. Gently clean the exterior surface,

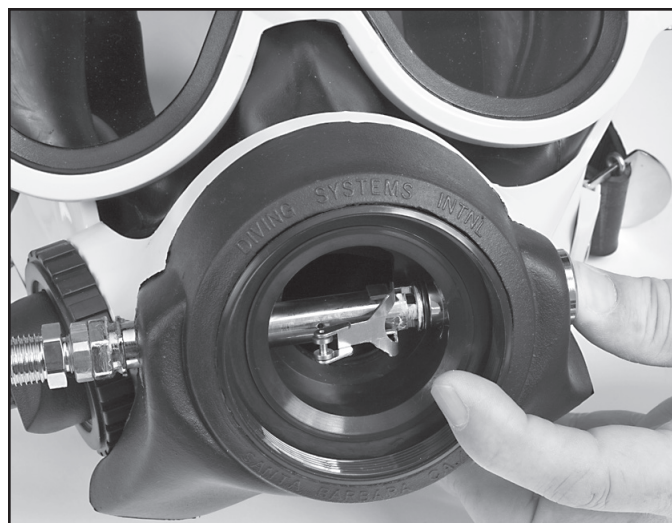

Carefully push the inlet tube into the regulator body.

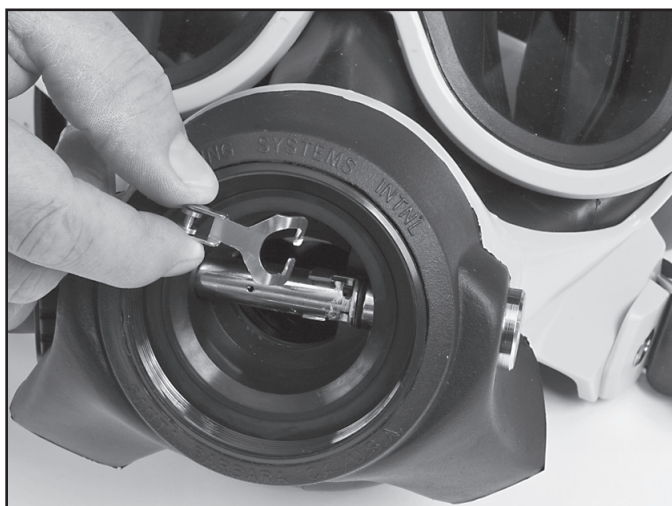

Remove the roller lever arm.

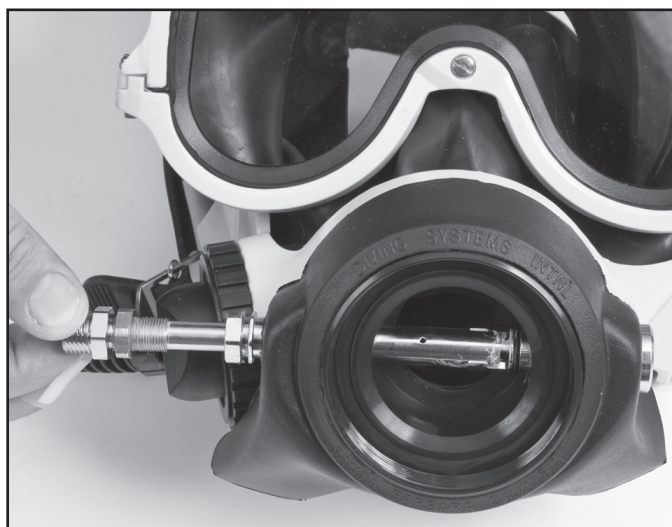

Removing the nipple tube.



Handle the inlet valve with care.

working the bristles in and around the O-ring grooves of the two static O-rings. Thoroughly rinse with fresh water and blow dry with compressed air. Inspect the exterior of the two O-rings for damage. Replace if any damage is found.

9. Using the toothbrush and soapy water, carefully scrub the inlet valve to remove all dirt, salts, and old lubricant. Normally, it is not necessary to remove the inlet valve O-ring in between annual overhauls, as long as the O-ring groove is not heavily corroded. If heavy corrosion is present, the O-ring should be removed using a plastic O-ring pick.

Using the nylon toothbrush, carefully clean the inlet valve by working the bristles carefully in and around the O-ring and O-ring groove. Rinse thoroughly with fresh water and blow dry with compressed air. Carefully inspect the O-ring groove by gently rocking the O-ring from side to side.

The O-ring groove should be free of pitting and corrosion damage. Carefully inspect the soft seat surface for cuts, nicks and abrasions. Normally, the soft seating area will have a slight round depression where it lays against the metal seat. This is normal.

Blow lightly through the 1/8" balance tube shaft with your lips to ensure air passes freely through the inlet valve. Replace the inlet valve if no flow is detected, or if any corrosion or soft seat damage is apparent.

10. Clean the regulator adjustment knob shaft and O-ring using the soapy water and toothbrush. Rinse thoroughly and blow dry. Carefully inspect the O-ring

for wear and damage replace if necessary.

11. Clean the inlet nipple tube using the toothbrush and soapy water. Gently work the bristles in and around the O-ring surfaces. Rinse thoroughly with fresh water and blow dry. Carefully inspect the O-rings for damage, replace if necessary. Carefully inspect the knife-edge of the nipple tube for nicks and dings.

The knife-edge of the nipple tube must be free of any damage. You should be able to feel any irregularities with your fingernail. If the tube is damaged it must be replaced.

After all parts have been cleaned and inspected. Lightly lubricate all O-rings and O-ring surfaces with silicone grease. Work the grease into the O-ring grooves then rotate the O-rings to spread the lubricant and wipe off any excess.

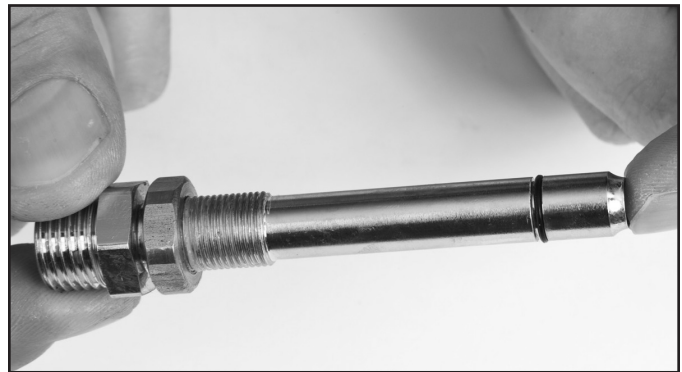

Inspect the nipple tube seating surface for dings, nicks, and wear. You should be able to feel any irregularities with your fingernail.

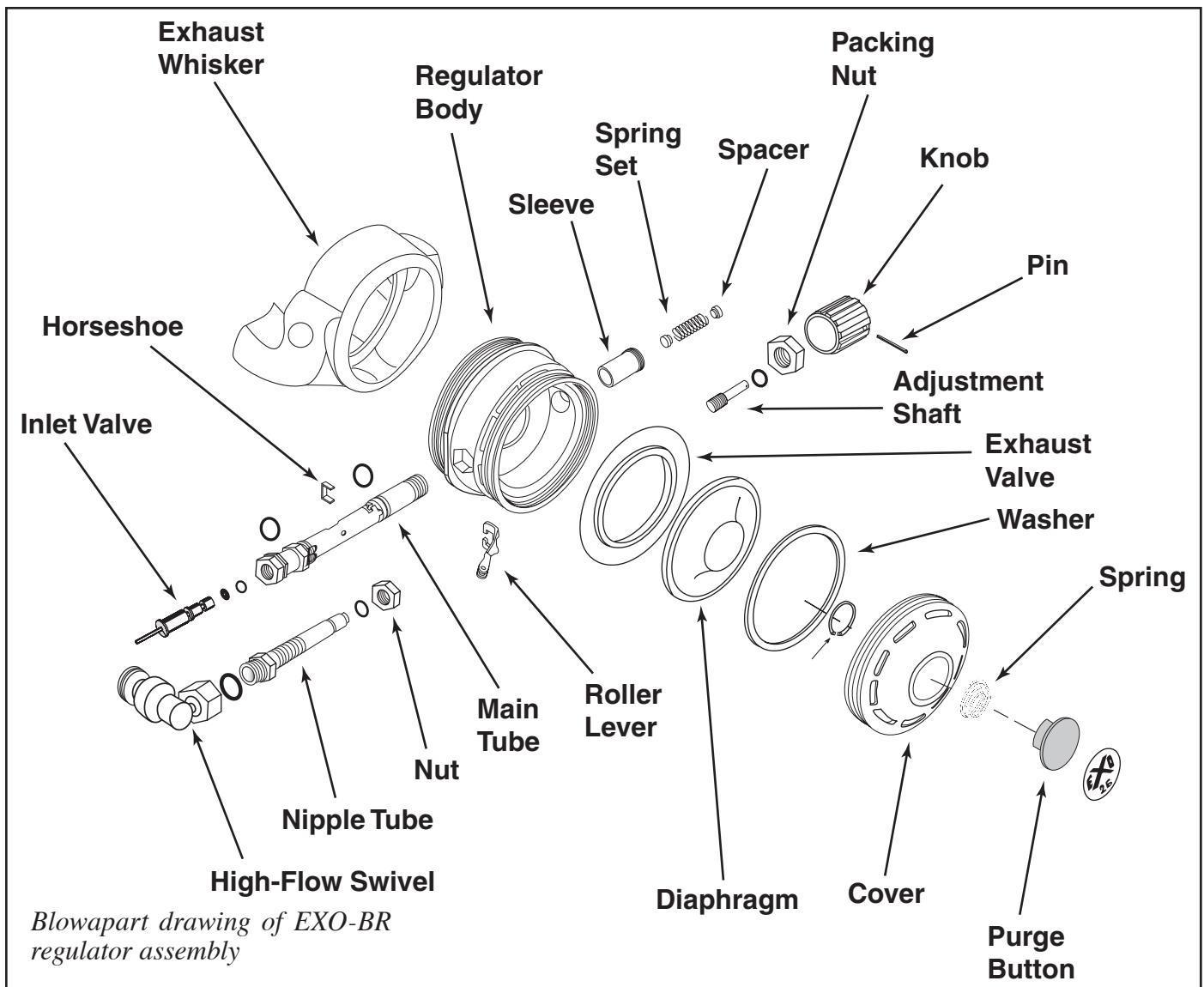

5.5 EXO-BR Regulator Reassembly

1) After all parts have been cleaned, inspected, and lubricated lightly with silicone grease as needed, make sure all O-rings are in their appropriate places.

2) If the main tube was completely removed from the regulator body, reinstall it by sliding it into the regulator body. The "B" that is machined into the main tube at the nipple end should be facing "up," i.e., towards the diaphragm, or exterior front of the mask.

Keep sliding the tube in until the horseshoe area of the main tube is centered in the regulator body. If the main tube was not removed it will already be positioned for acceptance of the horseshoe retainer.

Tip: When in this position, rotate the main tube 180 degrees to allow easier installation of the horseshoe

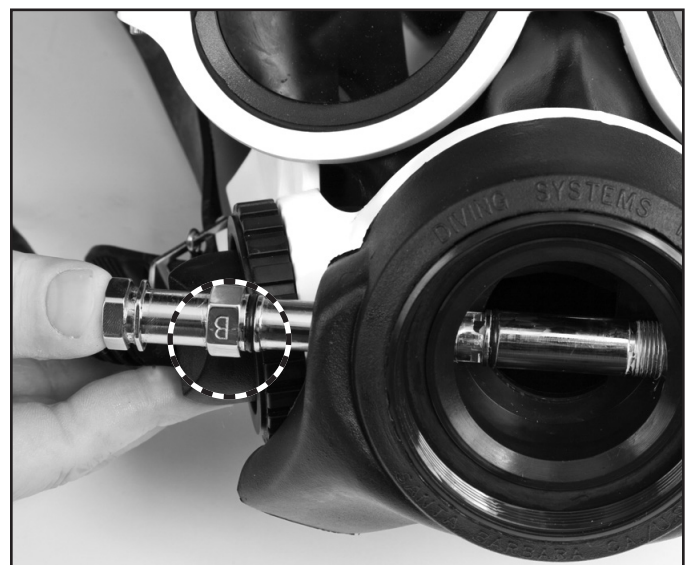

The B on the nipple tube should be facing "up," i.e., towards the diaphragm, or exterior front of the mask.



The horseshoe is critical to the proper function of the regulator.



Be sure to lubricate the inlet valve sparingly with silicone grease.

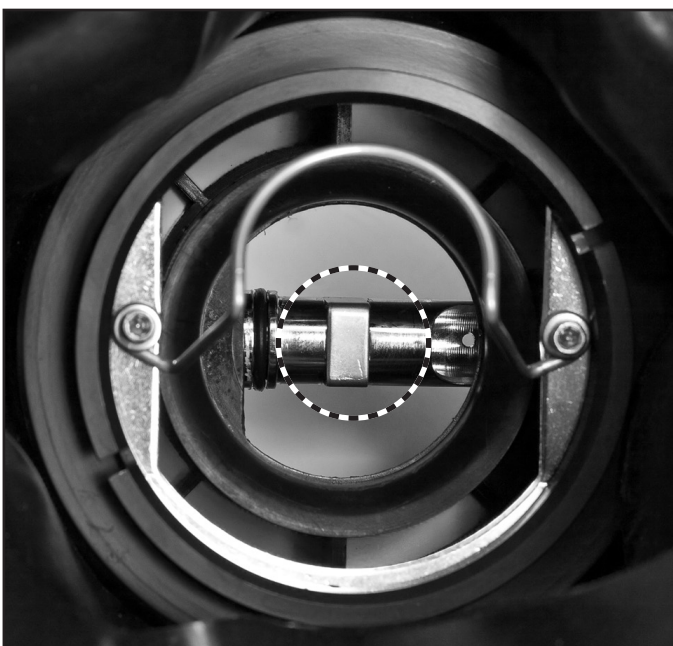

The horseshoe as seen from the interior of the regulator where it is installed on the main tube.



Installation of the spring set.

clip. Then rotate the main tube 180 degrees or follow step 3.

3) Slide the horseshoe into place on the main tube from inside the mask.

4) Slide the inlet valve into the main tube from the nipple tube side, sliding it in until the inlet valve is seated into the tube.

5) Slide the roller lever into the roller lever slot on the main tube. Make sure that the inlet valve is caught by the roller lever and push the main tube all the way into the regulator body. Make sure that the exhaust whisker is seated in the groove around the main tube at the nipple tube end.

6) Place the spacer, spring, and spacer together and slide this assembly into the main tube from the adjustment knob end. Make sure that the spacers go in

straight and move freely. (*Tip: It is easier to position the main tube straight up and insert the spring and spacers up into the tube.*)

7) Reinstall the adjustment knob assembly and tighten the packing nut. Always use a back up wrench on the other end of the main tube when tightening the packing nut to help prevent the main tube from damaging the regulator body. Tighten the packing nut to 40 inch pounds.

The lever arm should now have some spring tension and the spring into an up position when depressed and released.

8) Install the nipple tube into the main tube. Make sure the adjustment lock nut is all the way on the nipple tube before screwing it in. Screw the nipple tube in until the lever arm moves just slightly.

Note: If the knob is out too far when tightening the packing nut, the nut will not seal or tighten completely.

9) Make sure the lock nut is threaded all the way on the nipple tube. Screw the nipple tube in until you see the roller lever arm just move, and then stop. Lock the nut down against the main tube and put the diaphragm and washer with cover back on.

10) Install the diaphragm, washer and regulator cover assembly. Follow the Regulator Adjustment procedures in this chapter.



Install the regulator cover.

5.6 Regulator Assembly Removal and Installation

Tools required:

3/8" ratchet with an extension.

EXO Tool Kit, Deluxe. KMDSI Part #325-650.

This can be a difficult procedure. It is recommended that this procedure be done by a factory trained KMDSI dealer. If you are going to attempt this procedure ***read and understand this entire section before you start disassembly!***

If you are doing a regulator rebuild, the regulator must be removed from the from the mask in order to replace the exhaust valve.

5.6.1 Regulator Assembly Removal

- 1) Remove the spider and the communications module. See Chapter 6 and 7.
- 2) Remove the inlet tube of the EXO original (or cut the tie wrap if you have an old style oral/nasal) and remove the EXO Standard or BR oral nasal and equalizer.
- 3) On the EXO Standard or BR, remove the screws and washers that hold the wire retainer on and remove the wire retainer.
- 4) Using the regulator mount nut tool on a 3/8" ratchet with an extension is the easiest method of removing the regulator mount nut.
- 5) With the mask face down in your lap, place the regulator mount nut tool in the grooves of the regulator mount nut. Remove the regulator mount nut.
- 6) Remove the mount ring.
- 7) Gently pull straight out on the regulator assembly, removing it from the mask.

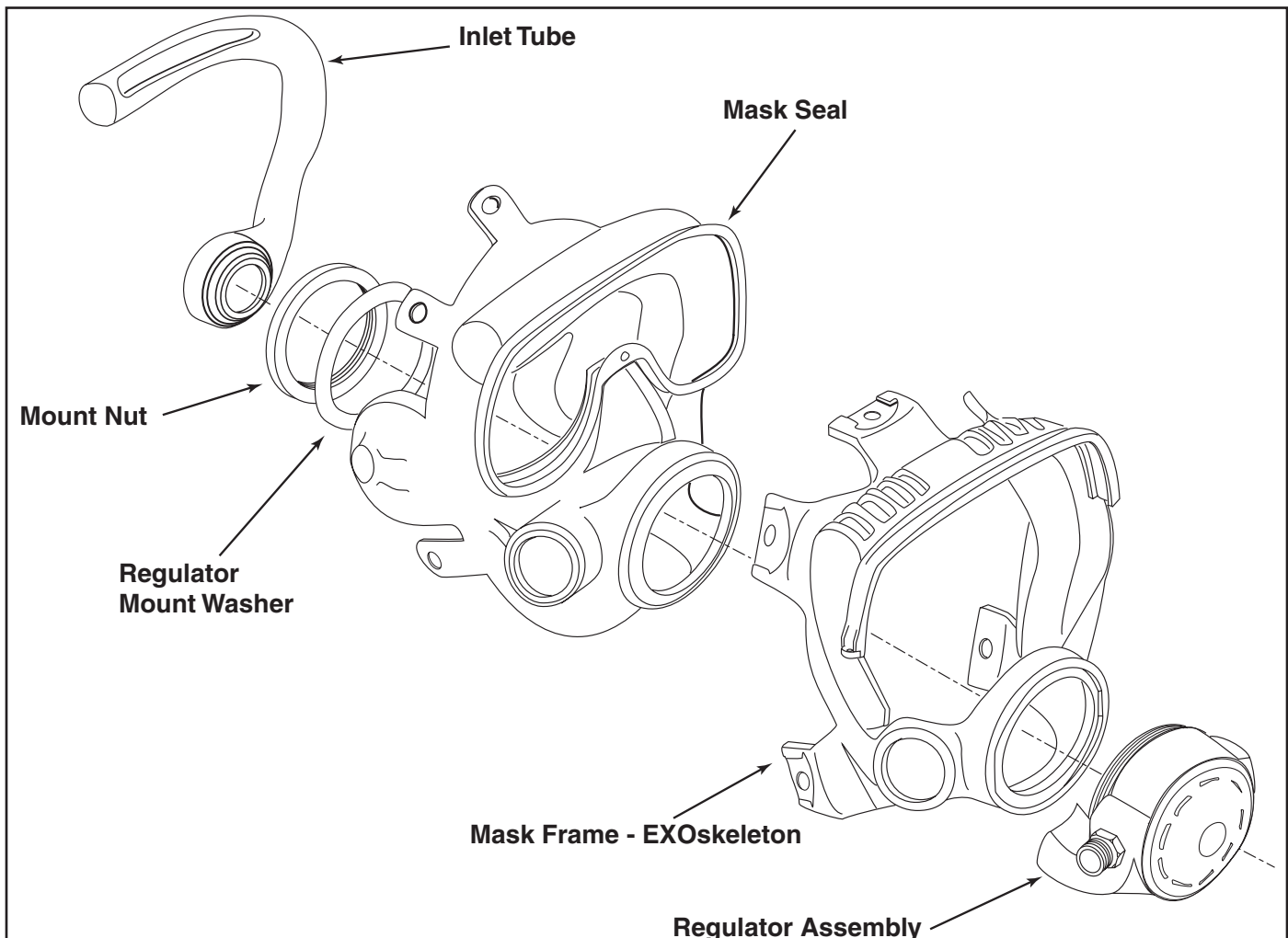

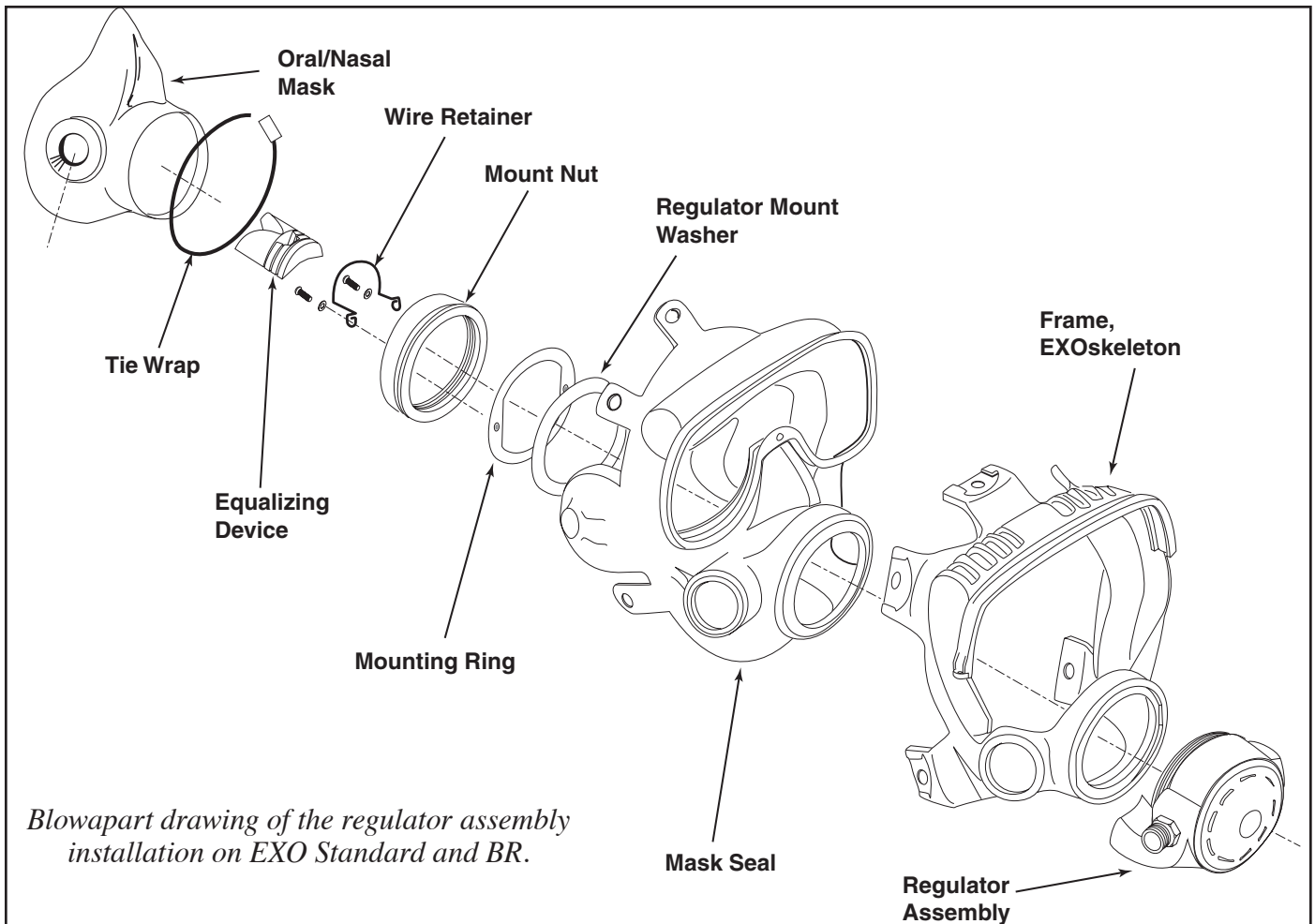

8) Remove the regulator mount washer from the inside of the mask.

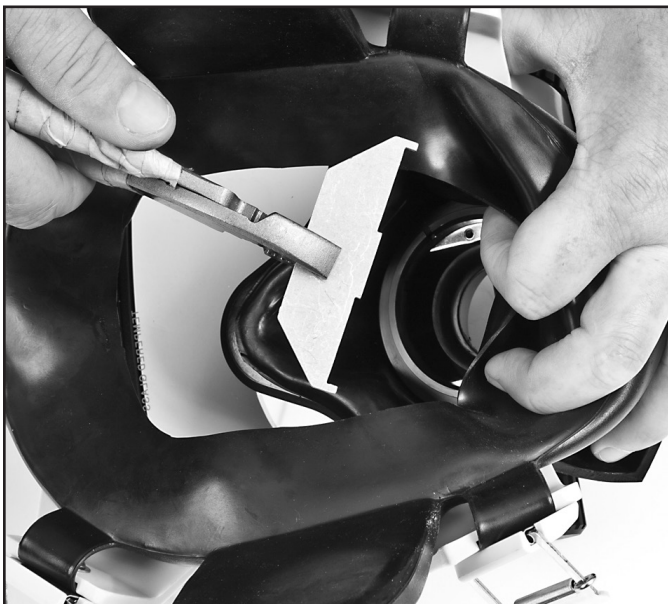

A pliers can also be used to grip and turn the regulator removal tool.



To remove the regulator, you must remove the regulator mount nut.

5.6.2 Regulator Assembly Installation

1) Inspect the mask seal in the regulator area for tears or holes and replace if damaged. Ensure that the mask seal is properly mounted into the frame. This is what seals the regulator to the mask. It is very important that the seal in this area remain correctly seated in the frame and does not get pushed through during all phases of installation.

2) Once the seal is correctly in place, lightly lubricate the inside of the regulator mounting hole in the mask seal with silicone grease. Do not get grease between the mask seal and the frame. If the grease gets between the frame and the mask seal, the mask seal will become unmounted and push through more easily when installing the regulator. Lightly grease the threads on the regulator body.

3) Holding the mask in one hand and the regulator assembly in the other with the exhaust whisker openings pointed down to the bottom of the mask, insert the regulator assembly into the mask. Hold the regulator at a slight angle when you first start to push it through the opening then straighten it out as you go in.

Start the threads of the regulator partially in on one side of the opening then work it into the hole. On the inside of the mask use your finger tips to support the mask seal to keep it from being pushed to the inside of the frame.

Once the regulator is in, visually inspect the mask seal on the inside of the mask and **make sure that the mask seal did not get pushed through and that it is still correctly seated on the frame.** If the seal has been pushed through, take the regulator out and try again.

Once the regulator is properly seated, inspect where the exhaust whisker meets the frame and make sure that the whisker is properly seated into the groove of the front of the regulator mount area on the frame.

4) Lightly lubricate the regulator mount washer and install it on the regulator.

5) Place the mount ring inside of the mount nut. The pressed in insert on the mount ring should have the bumps facing the regulator.

6) Thread the Mount Nut onto the regulator assembly. The mount nut must go on straight. **Do not cross thread!** It is easiest to start the mount nut by hand. Put the nut on the regulator, slowly turn counterclockwise until



Make sure that the mask seal did not get pushed through past the regulator body.

you feel the nut drop onto the threads (you may hear a slight "click" when this occurs). Then, gently thread on by hand as far as possible to ensure that it does not cross thread.

Cross threading can damage the regulator body. If the threads are damaged in any way the can must be replaced. Once the mount nut is on correctly, start tightening. Once again, check and make sure that the exhaust whisker is properly seated in the frame before final tightening. Tighten the regulator mount nut to 100 inch pounds.

7) Put the mount ring adjustment tool on the ratchet

The mount nut must not be cross threaded!



The mount ring adjustment tool is essential for correct mounting of the regulator.

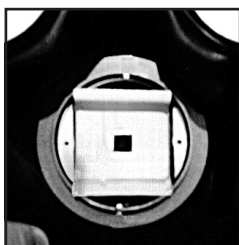

extension and mount the tool into the mount ring. Turn the mount ring until it is horizontally aligned (see photo this page).

8) On a EXO Standard or BR, reinstall the wire retainer with the screws and washers.

9) Reinstall the inlet tube (EXO Original) or:

10) Reinstall the oral nasal mask (EXO BR) and properly align the nose cavity. Make certain the round mount lip is properly / completely inserted into the mating groove found on the regulator oral nasal mount nut.

11) If you are using the new style silicone oral/nasal a tie wrap is not required for installation. However, if you are using the old style oral/nasal, install the new tie wrap. Insert the tail of the tie wrap into the head and pull it through about 1.5". This will allow enough circle to fit over everything during installation. Begin installation by carefully folding the oral nasal mask in on itself only enough to allow the tie wrap to pass over the outside of it.

Be careful not to displace the oral nasal from the groove of the regulator mounting ring. Double check making sure the oral nasal is seated in the groove. Carefully begin tightening the tie wrap, while pushing it down against the regulator mount nut. Direct the head of the tie wrap towards the channel inside the main mask cavity, found at about the 9:00 O'clock position.

Before the tie wrap is closed tight, check again to be sure the oral nasal is still in the groove. Hold the tie wrap down against the mount nut and tighten with needle nose pliers. Snip off any excess tie wrap material as close to the head as possible.

Check the installation by lightly tugging at the oral nasal. It should remain seated. If it pulls free, repeat steps 4 thru 9 with a new tie wrap.

If the installation tests properly, reinstall the microphone into the pocket in the oral nasal. Re install the nose

equalizing device onto it's mount.

12) Reinstall the communications in accordance with Chapter 6.

5.7 EXO Regulator Adjustment

NOTE: After working on the regulator it must be checked for proper adjustment and function. You do not need to let the EXO regulator sit for 24 hours. Make certain the inlet nipple and inlet valve were pre-set properly before final adjustment.

- 1) Ensure the diaphragm cover and diaphragm are removed and the inlet nipple and lock nut are loose, then back the inlet nipple out counter clockwise about four to five turns.
- 2) Adjust the adjustment knob in fully clockwise then back it out 3 full turns.
- 3) Rotate the inlet nipple in slowly until the lever starts to drop then stop. Snug the locknut by hand to keep the inlet nipple from moving.
- 4) Attach an air source at a supply pressure of between 135 and 150 p.s.i.g.
- 5) Slowly pressurize the regulator then back out on the adjustment knob until a slight free flow develops then rotate back in until the free flow just stops.

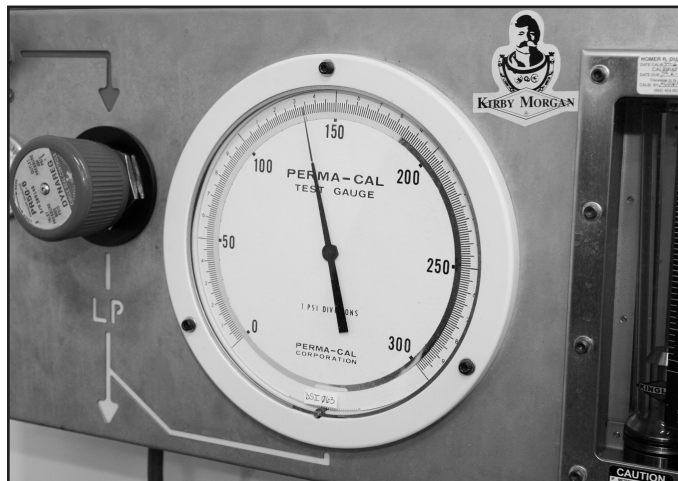

Use a supply pressure of 135-150 p.s.i. to adjust the regulator.

At this point adjust the lever so that it has between 1/16th to 1/8" of free play at the end of the lever. To increase the play in the lever, turn the inlet nipple 1/8 of a turn at a time. To decrease the lever play, rotate the inlet nipple counter clockwise 1/8 of a turn or less at a time.

6) Once the end play of between 1/16th to 1/8" has been achieved, tighten the lock nut against the main tube using the two flat wrenches in the tool kit.



Use the spanner wrench to depress the purge button while turning the nipple to adjust the regulator.

- 7) Install the diaphragm, thrust washer, and secure the cover.
- 8) Lightly depress the purge button. A slight flow of gas should be heard when the purge button is depressed 1/16-1/8", and a strong purge should be present when the button is fully depressed.
- 9) Once the regulator is installed and adjusted the retainer wire for the equalizer device is installed. Tighten the screws to 10 inch pounds.
- 10) Install the nose block/equalizing device rubber pad at the correct height for your face.



After the regulator is adjusted, install the wire retainer for the equalizing device.



Install the nose block rubber pad at the appropriate height for your face.



Tighten the screws for the nose block wire retainer.

5.8 Manifold Block Maintenance

5.8.1 Daily Maintenance

A daily pre-dive inspection should be done prior to using the Manifold Block. Carefully inspect the assembly for any sign of damage or worn components.

Tools: open end wrenches, 1", 11/16", 9/16", 5/8" and a 5/16 Allen wrench.

- 1) Check to ensure all the port plugs are installed and are tight.
- 2) Check to ensure the auxiliary gas supply whip is installed and tight, on the auxiliary valve
- 3) Using a 5/8" open-end wrench, check to ensure the packing nut on the auxiliary valve is snug. Note: do not over-tighten. The valve handle should turn freely. Check to ensure the packing nut does not turn -when a light force is applied with the wrench.
- 4) Ensure the non-return valve and umbilical adapter are securely in place.
- 5) Test the one way valve by sucking on the inlet fitting with your lips. If any air is drawn through the valves the valve must be rebuilt or replaced.

5.8.2 Post Dive Procedures

Daily post dive maintenance of the manifold block requires a brushing with a solution of mild soapy water and a thorough rinsing with fresh water. If hoses have been removed, ensure port plugs have been installed and the umbilical connection has been capped or bagged.

5.8.3 Annual Overhaul of the Manifold Block Assembly

The KMDSI manifold block should be rebuilt on an annual basis, or when damage or corrosion is suspected or found.

Tools required: Table vise, 1 "open end wrench (2ea), 1 1/16", 5/8", and 9/16" open end wrenches, large flat blade screwdriver, 5/16 Allen wrench, 0-300 in lbs. torque wrench, Soft nylon tooth brush, brass O-ring pick and a solution of 50/50 white vinegar and water.

Parts required:
Manifold Repair Kit KMDSI PN 325-095

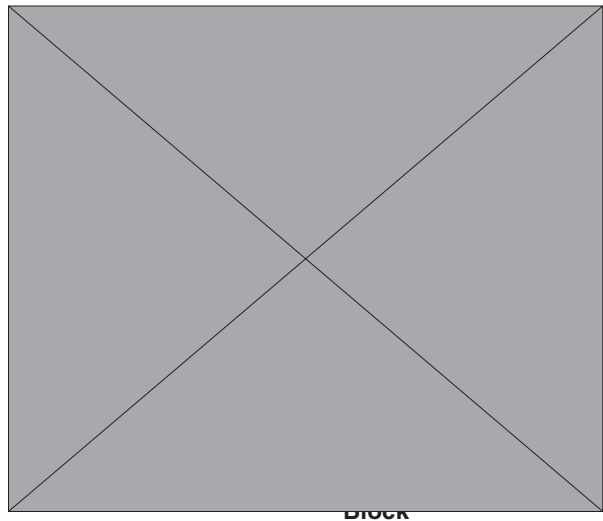

5.8.3.1 Disassembly Of Manifold Block

- 1) Remove the two flat head screws from the manifold backing plate, and remove the plate.
- 2) Remove all hoses and port plugs. Remove the O-ring from each plug and place the plugs in a solution of 50/50 white vinegar and water.
- 3) Using a soft jaw vise or a rag wrapped around the manifold block to keep from marring the finish, remove the one way valve from the manifold block using the 1" wrench.

NOTE: The one way valve must be removed from the manifold block before the auxiliary valve.

- 4) Using the 9/16 open-end wrench, loosen and remove the auxiliary valve from the manifold block.
- 5) Place the manifold block body in a solution of vinegar and water, and allow to soak while the other components are being disassembled. Using the 1" wrench and the 9/16 wrench, loosen and remove the umbilical adapter fitting. Place it in the vinegar solution.

- 6) Carefully clean the manifold block body with a nylon toothbrush and vinegar solution. Remove all traces of old lubricants, dirt and corrosion, rinse with fresh water and blow dry with compressed air or allow to air dry.

Using the nylon brush, clean the manifold plate and umbilical adapter. Take special care to remove all the old Teflon tape from the threads of the umbilical adapter. Air or blow dry. Inspect all threaded ports for any damage.

5.8.3.2 Disassembly and Cleaning of the One Way Valve.

Tools Required:

Soft Jaw Vice

1 inch Open End Wrench Attachment
on Torque Wrench

(If no vise is available use a backup 1 inch open end
wrench)

To disassemble and inspect the one way valve assembly:

1) Use two wrenches or hold the hex part of the body in
a soft jaw vise while removing the seat with a wrench.

As the seat is removed, the wiper and the O-ring slide

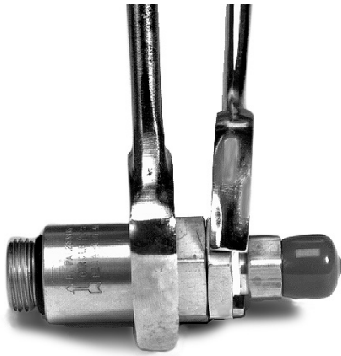
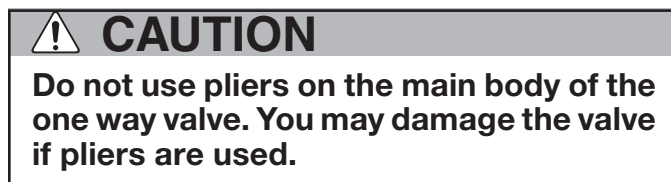

Never use pliers on the one-way valve!

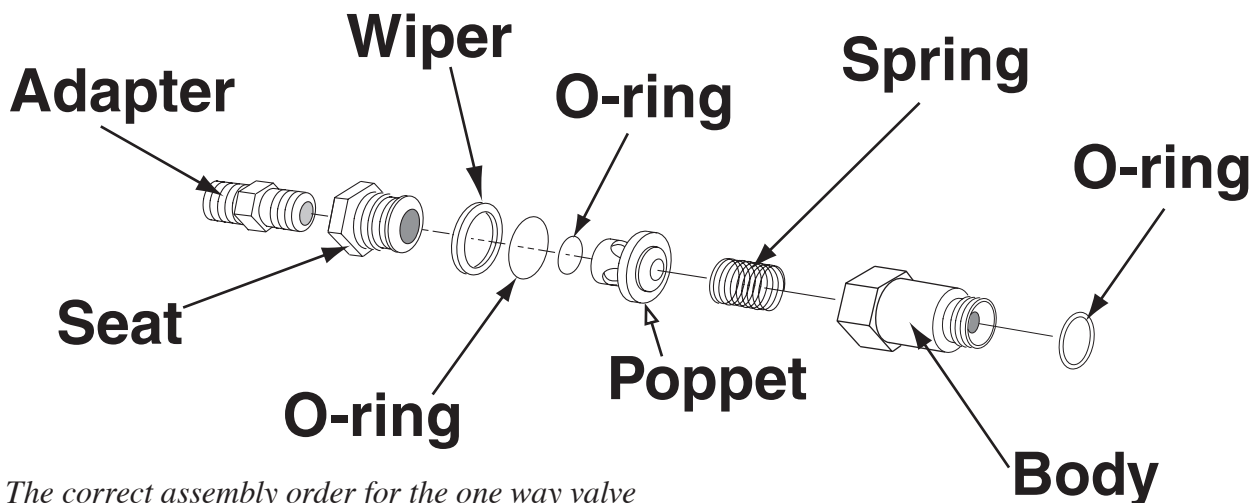

The correct assembly order for the one way valve

out in place in a groove on the seat. The poppet and the poppet O-ring usually come out in the seat being followed by the spring. The only functional part remaining in the valve body is a non-moving, pressed-in cage. The function of the cage is to prevent the poppet O-ring from blowing out of place during high flows.

2) Inspect the body interior for foreign matter of any type and clean, if necessary.

3) Inspect the seat, wiper, O-ring, poppet O-ring and poppet for wear, replace if necessary. Be sure each part is clean. A repair kit is available for replacement parts. (KMDSI Part #525-330)

4) Place silicone lubricant on the components, then wipe clean with a non-lint producing cloth. Be careful to wipe the poppet and poppet O-ring thoroughly, removing nearly all silicone to prevent foreign materials from sticking to these components.

5) Inspect the spring and clean or replace if necessary.

5.8.3.3 Reassembly of the One Way Valve

1) Slide the new O-ring over the poppet.

2) Insert the new spring into the valve body, followed by the poppet.

3) Next, install the new O-ring and new wiper on the seat. Thread the seat into the valve body .

4) Tighten the seat to 150 inch pounds with a torque wrench while holding the body in a soft jaw vice or

with another wrench.

5) Re-tape the pipe threads on the umbilical adapter fitting with Teflon tape, starting two threads back. One and one half wraps is all that is required. Reinstall the umbilical adapter and securely tighten.

NOTE: The one way valve must be installed in the manifold block after the auxiliary valve.

6) Lightly lubricate a new O-ring, and install onto the one way valve body. Reinstall the one way valve into the manifold block only after the auxiliary valve has been installed. Torque to 150 inch pounds.

5.8.3.4 Disassembly of the Emergency Gas Supply Valve

Tools Required:

11/16 inch Open End Attachment on Torque Wrench
 1 inch Open End Attachment on Torque Wrench
 3/8 inch Slotted Flat Blade Screwdriver
 8 inch Adjustable Wrench

1) To remove the auxiliary valve body from the manifold block the one way valve assembly must first be removed.

NOTE: If only the auxiliary valve is being serviced, it does not have to be removed from the manifold block to be rebuilt.

2) Remove the lock nut, spring, and knob.

3) Undo the packing nut. When the packing nut is free of the threads of the auxiliary valve body (8), back out the stem until it is free of the auxiliary valve body.

4) Remove the packing nut, packing, and washer from the stem.

5.8.3.5 Cleaning and Lubricating the Emergency Gas Supply Valve

1) Clean all the metal parts in a 50/50 dilute solution of white vinegar/water. Rinse with fresh water.

2) Inspect the packing and washer for wear and replace if necessary.

3) Inspect the stem seat for unevenness or wear and replace if necessary. It must also be replaced if the stem is bent.

4) Check the seat in the auxiliary valve body for wear or unevenness. Replace the body if necessary.

5.8.3.6 Reassembly of Emergency Gas Supply Valve

Tools Required:

11/16 inch Open End & 1 inch Open End Attachments on Torque Wrench
 3/8 inch Slotted Flat Blade Screwdriver
 Soft jaw vice, Teflon tape

1) With the exception of the tapered pipe thread end of the auxiliary valve body, lubricate all components with a light coating of silicone grease.

2) Place the new Teflon washer and new packing on the stem. *NOTE: There are two different packings and washers supplied in the kit, for rebuilding both the older style and the newer high flow auxiliary valve. Match the removed packing and washer to the new ones supplied and discard the others.*

Components of the Emergency Gas Supply Valve

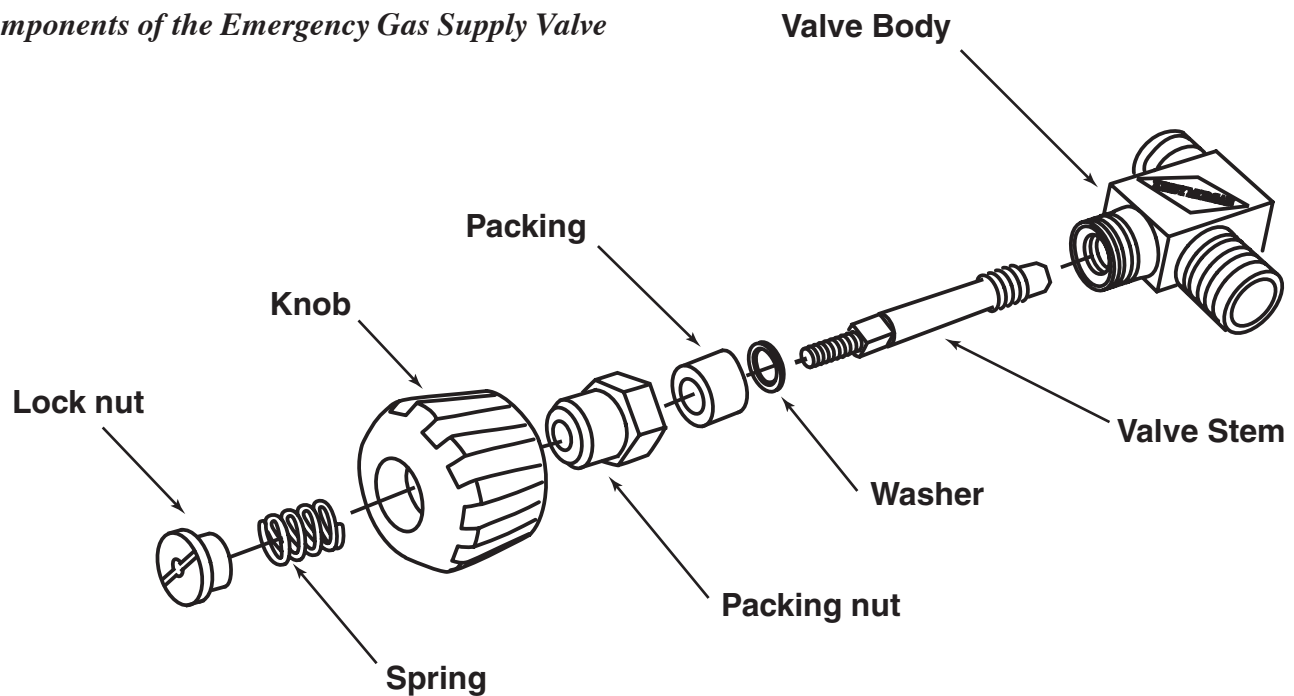

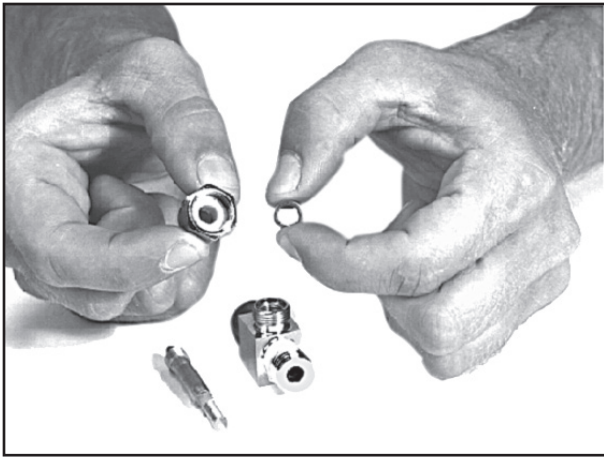

Inspect the packing and washer

- 3) Holding these components in place on the stem, screw the stem into the auxiliary valve body.
- 4) Rotate the stem until it is seated all the way in.
- 5) Thread the packing nut onto the body. Run the nut in and tighten slightly with a wrench.
- 6) Place the knob onto the stem and rotate the stem all the way out, then back again. The rotation must be smooth. If “hard spots” or unevenness are felt during the rotation, the stem may be bent and could need replacement.
- 7) Tighten the packing nut with a wrench until moderate resistance is felt when turning the knob.
- 8) Place the spring and locknut onto the stem, securing the knob.
- 9) Tighten the locknut until the screwdriver makes contact with the stem. The assembly is now complete and ready for testing.
- 10) Test the valve by attaching it to an auxiliary air

supply source. There must be no leakage of gas past the stem or through the packing nut. Turn on the bail-out bottle and leave the supply on for several hours. There must be no drop in pressure in the system if the valve is operating properly.

11) Apply Teflon tape to the pipe threads starting two threads back. Only one and one half wraps is all that is necessary.

12) Reinstall the auxiliary valve into the manifold block and tighten. Ensure the valve body is oriented in the proper position so that the one way valve can be reinstalled.

WARNING

Take care not to allow any pieces of Teflon tape to enter the manifold block. If these pieces of tape enter the demand regulator assembly they may block the flow of air to the diver. This could lead to death from suffocation.

5.9 Overpressure Relief Valve (P/N 200-017) Overhaul Procedures

Over Pressure Relief Valve Component Breakdown

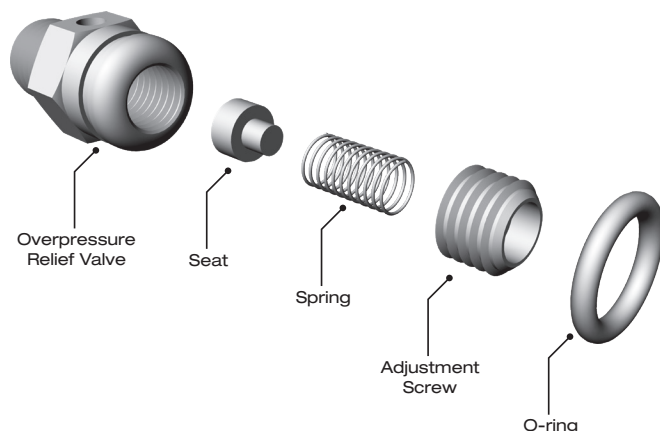

5.9.1 Overpressure Relief Valve General

The overpressure relief valve should *always* be used on all Emergency Gas Supply (EGS/bail-out) first stage regulators to prevent the hose from rupturing in the event the first stage pressure creeps. The Kirby Morgan relief body is made of stainless steel.

The basic components last a long time but the valve should be disassembled, cleaned, and inspected at least once a year or whenever it fails testing. The valve should be tested monthly. Cleaning and overhaul is easily performed using a nylon toothbrush and a 50/50 solution of vinegar and fresh water. Cleaning for 15 minutes in an ultrasonic sink, if available, with the 50/50 vinegar solution is highly recommended.

Repair parts are available. Order P/N 225-017 Overpressure Relief Valve Rebuild Kit, which contains the O-ring, soft seat, spring, and adjustment screw. The O-ring should be replaced at least annually. The other parts require replacement only if worn or damaged. An exploded view of the valve is located in all KMDSI Helmet and Band Mask Operations and Maintenance Manuals. The descriptions used on the next two pages refer to the drawing on this page.

Tools Required.

Torque wrench
1/2" open-end wrench attachment for torque wrench
1/8" Allen wrench

Nylon toothbrush
Vinegar, Fresh water
Mild dish soap
Ultrasonic sink, if available
Magnifying glass
New valve body o-ring

5.9.2 Overpressure Relief Valve Disassembly and Cleaning

WARNING

Do not use cleaning solvents (i.e. mineral spirits, bleach, etc.) when cleaning the overpressure relief valve. The use of cleaning solvents may lead to failure of the overpressure relief valve.

- 1) Turn off the gas supply to the first stage regulator, then bleed off any remaining pressure. Remove the first stage regulator from the air/breathing gas source so it cannot be accidentally turned on, i.e., pressurized. Make sure the intermediate pressure in the regulator hose is also fully drained of pressure.
- 2) Remove the overpressure relief valve from the regulator body using the 1/2" open-end wrench.
- 3) Remove, cut, and discard the overpressure relief valve body O-ring.
- 4) Using the 1/2" open-end wrench to hold the overpressure relief valve body, use the 1/8" Allen wrench to remove the Allen head adjustment screw. Then, shake out the spring and soft seat.
- 5) Place all parts in the 50/50 solution of vinegar and water and allow to soak for 15 to 30 minutes. If using an ultrasonic sink, reduce time to 15 minutes.
- 6) Using the nylon toothbrush, brush all components to remove corrosion and mineral deposits. Then, rinse with fresh water and blow or air dry.
- 7) Using the magnifying glass, carefully inspect all components for excessive corrosion and/or damage. Replace the spring and/or adjustment screw, if either part is excessively corroded or shows signs of wear and/or damage.

Inspect the soft seat for nicks, cuts, and wear and replace if any damage is found. Replace the entire assembly if any damage to the valve body is present.

NOTE: A deep groove in the soft seat is normal. Replacement is only necessary if the rubber seat is deteriorated, cut, and/or chipped.

5.9.3 Overpressure Relief Valve Reassembly

1) After cleaning, inspection and/or parts replacement, reassemble the valve by installing the soft seat, spring, and adjustment screw. Tighten the adjustment screw down until it is approximately 1/2 thread from being flush with the top of the valve body.

2) Lightly lubricate a new body O-ring, then install on the valve body.

3) Test the overpressure relief valve according to the test procedure below.

5.9.4 Overpressure Relief Valve Lift Check/ Setting

Tools required:

Adjustable first stage scuba regulator or controlled adjustable pressure source

Intermediate pressure test gauge

Torque wrench

1/2" open-end wrench adapter for torque wrench

1/8" Allen wrench

HP air source {SCUBA tank} with at least 500 p.s.i.g. (34.4 bar).

Mild dish soap

The purpose of lift checking the overpressure relief valve is to ensure it operates properly, allowing excess pressure to escape in the event the first stage develops a slight leak. Without the overpressure relief valve, high-pressure gas will continue to increase until the emergency supply hose ruptures, possibly causing injury and a complete loss of the Emergency Gas System (EGS).

! WARNING



Ensure the overpressure relief valve is only installed in a low-pressure port of the first stage regulator. Installation in a high-pressure port will lead to loss of EGS supply and possible serious personal injury if the valve fails.

This procedure explains the steps necessary for readjusting the overpressure relief valve after it is cleaned, overhauled or any time the valve is tested.

NOTE: The overpressure relief valve is lift checked and/or adjusted using an adjustable first stage regulator, equipped with a low-pressure test gauge, which is used for adjusting the intermediate pressure of scuba regulators. The check/adjustment can be performed using a standard scuba test stand, or a gas control console, using air or mixed gas with an oxygen content below 23% by volume.

! WARNING

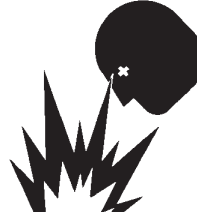

Do not use oxygen, or mixed gas containing more than 50% oxygen by volume, for lift checking the overpressure relief valve. The use of oxygen, or mixed gas, in a high-pressure supply system not designed and cleaned for oxygen service, can result in a fire or explosion causing serious injury or death.

If a first stage scuba regulator is used, it must be able to be adjusted to the desired lifting pressure. The pressure gauge should be compared to a gauge of known accuracy.

NOTE: If the Allen screw on the overpressure relief valve hex nut is rotated too far, too fast, the overpressure relief valve will pop open. This could possibly require the air to be secured at the cylinder or supply source to reset the seat before the adjustment can be accomplished.

NOTE: The overpressure relief valve can be installed in any first stage regulator, providing the first stage has an intermediate setting of 135 - 165 p.s.i.g. (9.3 - 11.4 bar).

1) Install the P/N 200-017 overpressure relief valve into a low-pressure port on an adjustable 1st stage regulator, using 20 inch pounds torque. Or install on the scuba test stand.

2) Install the intermediate pressure gauge in one of the low-pressure ports of the first stage regulator.

3) Install the 1st stage regulator on the cylinder. Ensure

the relief valve and intermediate pressure gauge are attached to low-pressure ports.

4) Wet the relief valve with soapy water to help indicate gas flow

5) Slowly bring up air pressure while watching the intermediate pressure gauge until the pressure gauge indicates 180- 200 p.s.i.g. (12.40-13.78 bar). If the relief valve starts venting at a pressure below 180- 200 p.s.i.g. (12.40-13.78 bar), secure the air supply and adjust the adjustment screw (1) in (clockwise) 1/8th turn. Slowly bring up pressure and recheck.

Continue this procedure as necessary until the relief valve consistently vents at a pressure between 180- 200 p.s.i.g. (12.40-13.78 bar). If the valve does not start venting when the gauge reads 200 p.s.i.g. (13.78 bar), slowly back out on the adjustment screw (counter clockwise) until the valve starts venting, forming bubbles in the soap solution.

6) After the valve has been adjusted, adjust the 1st stage regulator intermediate setting to 135 p.s.i.g. (9.3 bar), re-wet the valve, then slowly increase the intermediate pressure on the 1st stage regulator one last time to recheck the lift pressure. The valve should start forming bubbles or venting at between 180- 200 p.s.i.g. (12.40-13.78 bar).

7) After final lift check reset the regulator to the appropriate over bottom setting. Remove the intermediate pressure gauge.

TROUBLESHOOTING

Problem: Valve pops open and will not stop flowing:

Check: If while setting the overpressure relief valve the valve pops open and will not stop flowing, secure the air supply valve and allow the valve to reseat. Try the procedure again, ensuring that the supply valve is only slightly cracked open, allowing full test pressure but minimizing high flow potential.

Problem: After resetting the first stage to 135 p.s.i.g. (9.3 bar), the valve continues to leak:

Check: This indicates the valve body, seating surface or the soft seat is either dirty or damaged. Usually, cleaning both the metal body, seating surface in the valve body and the soft seat will fix the problem.

If, after cleaning, the problem persists, replace the soft seat and spring and retest the unit. If the seat continues to leak, then replacement of the complete valve will be necessary.

The purpose of lift checking the valve is to ensure the relief operates properly allowing excess pressure to escape in the event the first stage develops a slight leak. This procedure also explains the steps necessary for readjusting after cleaning or overhaul.

Chapter 6

Frame And Lens Repairs

6.1 General Information

All maintenance on the frame of the EXO Full-Face mask can be accomplished with common hand tools.

6.2 Lens Replacement

Tools required:

Dow DC-111 or similar silicone grease

7/64" Allen head wrench, flat blade screwdriver, torque screwdriver.

6.2.1 Lens Removal

1) Use a 7/64" Allen head wrench to remove the two screws and washers from the sides of the lens clamp. Remove the Nylon lock nuts if they are loose in the frame.

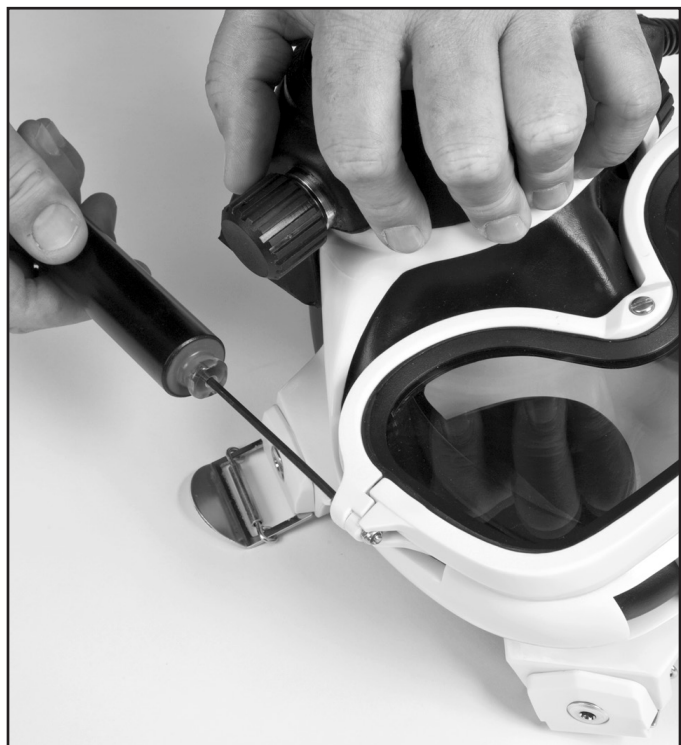

To remove the lens, you must remove the two screws at the sides of the lens clamp.



Remove the screw and washer from the front of the lens clamp in the nose area.

2) Remove the screw and washer from the front of the lens clamp in the nose area.

3) Separate the lens clamp from the mask frame and mask seal.

4) Carefully remove the old lens from the mask seal by sliding the lens down enough to clear the top of the lens clamp (which is part of the frame). Remove any silicone from the rubber channel in the mask seal.

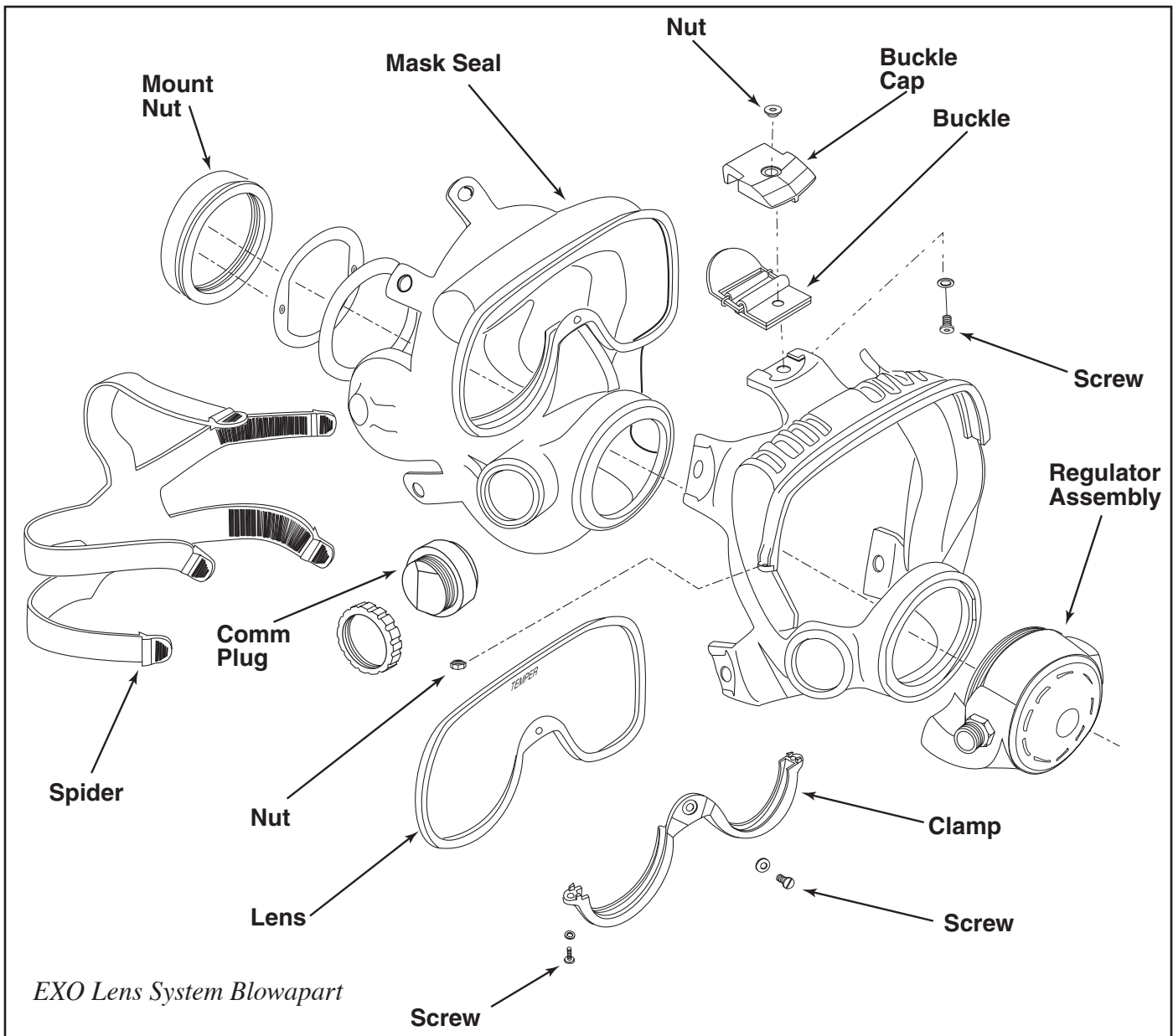

6.2.2 Lens Installation

1) The top lens clamp (which is part of the frame) has flats that will hold the Nyloc lock nuts in place. If the locking feature of this nut is worn out or no longer works, **these nuts must be replaced.** **DO NOT use any chemical locking liquids anywhere on the mask.** *These chemicals can attack and damage the mask frame material.*



Do not use ANY chemical locking liquids anywhere on the mask!

⚠ WARNING
DO NOT use any chemical locking liquids anywhere on the mask. These chemicals can attack and damage the mask frame material. This could cause the frame to fail without warning.

Install the nuts in the upper lens clamp part of the frame, carefully using needle nose pliers if needed. Be sure they are positioned properly and securely. Do not squeeze them too tightly or you may damage the plastic shelf where they seat.



Apply silicone grease to the mask seal.



Adjust the seal around the bottom of the lens.



Install the right side of the lens rim into the channel of the rubber on the mask seal.

2) Place a bead (approximately 1/8 inch diameter) of Dow DC-111 Lubricant or similar **silicone** grease across the entire top lens groove of the main mask seal. It should start at approximately 3/4 inch below the top lens clamp corners and go to the same spot on the opposite side.

3) With the word **TEMPERED** facing out, hold the lens up slightly at an angle and begin to install the right side of the lens rim into the channel of the rubber on the mask seal. Make sure that the mask seal is seated in the mask frame correctly.

Start installing the lens slightly below the top lens clamp for clearance when installing. Push the lens to the side far enough to make the plastic clamp flex slightly outward allowing the lens to be fitted into place on the other side.

4) Lower the left side of the lens towards the opposite side of the mask rubber and clamp. Just before they meet, grab the edge of the rubber channel and pull it up slightly above the outer edge of the upper lens clamp and press the lens into the rubber channel and then into the upper lens clamp.



Install the lens clamp that connects to the mask frame.

5) Push the lens up and into the rubber channel of the mask seal and top of the upper lens clamp. Hold the lens in position and fit the bottom channel of the rubber mask seal on the bottom edge of the lens.

6) Once the lens is properly seated in the mask seal and upper lens clamp, install the lower lens clamp. Place the two ends of the bottom of the clamp onto the outside of the rubber channel to hold the rubber in position. Work the clamp onto the mask starting at the nose. Make sure the rubber is seated evenly onto the lens rim and into the lens clamp.

7) Push up on the area under the nose screw to align the nose screw hole in the lens clamp with the hole in the rubber and the thread insert in the plastic rim on the lens. Insert the slotted screw and the washer here and tighten only about 3 or 4 turns. **Do not snug or finish tightening the screw at this time!**



Use a flat blade screwdriver to keep the mask seal from pinching as the lens clamp is tightened.



Check the seating of the mask seal and lens clamps on the inside of the mask.

⚠ CAUTION

DONOT OVER TIGHTEN THE LENS MOUNT SCREWS. Over tightening can cause damage to both the lower lens clamp and the upper clamp/frame requiring replacement.

8) Pull up on the lower lens clamp and install the Allen head screws through the clamp until they thread into the nuts in the upper lens clamp part of the frame. Lightly tighten these screws, alternately tightening from side to side so the clamp is drawn up evenly, but do not tighten all the way.

9) Finish tightening the nose screw using an inch pound torque screwdriver set at **6 inch pounds**.

10) Finish tightening the Allen head clamp screws. Use a flat blade screwdriver very gently if needed to keep the rubber from pinching between the two clamps. Tighten the clamps until they bottom against each other. **Do not over tighten.**

11) Check the inside top of the glass where it meets the rubber and make sure everything is properly seated. Check both sides of the lens and seal. If any excess silicon grease has squeezed out, remove it.



Check the gap on both sides of the lens to be sure it is equal.

6.3 Buckle Replacement

Note: The "T" Nuts are made with a special one time thread locking feature. If the buckles are to be removed the "T" Nuts must be replaced.

Note: By shortening the short leg of the 1/8" Allen wrench (see photo) this job is made much easier.

6.3.1 Buckle Removal

- 1) Remove the spider (Head harness)
- 2) Use a 3/16" Allen wrench to remove the "T" nuts and a 1/8" Allen wrench to remove the screws that hold the buckles and buckle caps on.

6.3.2 Buckle Installation

- 1) Install all the washers onto the screws with the sharp side of the washer towards the head of the screw.
- 2) Fit the buckles up into the bottom side of the buckle caps. Ensure that the buckles are facing the right way. The folded piece of the buckle assembly with the mounting hole through it has a loop in it. This loop should fit into the space on the bottom side of the buckle caps.

! WARNING

If the "T" nuts are not properly installed there is the possibility the screw will become loose and fall out. This will result in the loss of an entire buckle assembly and could cause the mask to flood if enough buckles are lost. Flooding the mask could lead to drowning and death.

Become familiar with the way the washers should fit to the "T" nuts. When properly installed the washers will fit around the minor diameter of the "T" nut when properly in place. The washer MUST NOT be captured between the head of the Allen screw and the end of the "T" nut when tightened.

- 3) Fit the "T" nuts through the top sides of the buckle cap and through the mounting hole in the buckle.
- 4) Apply a small amount of silicone grease to the hole on the tab of the mask seal.

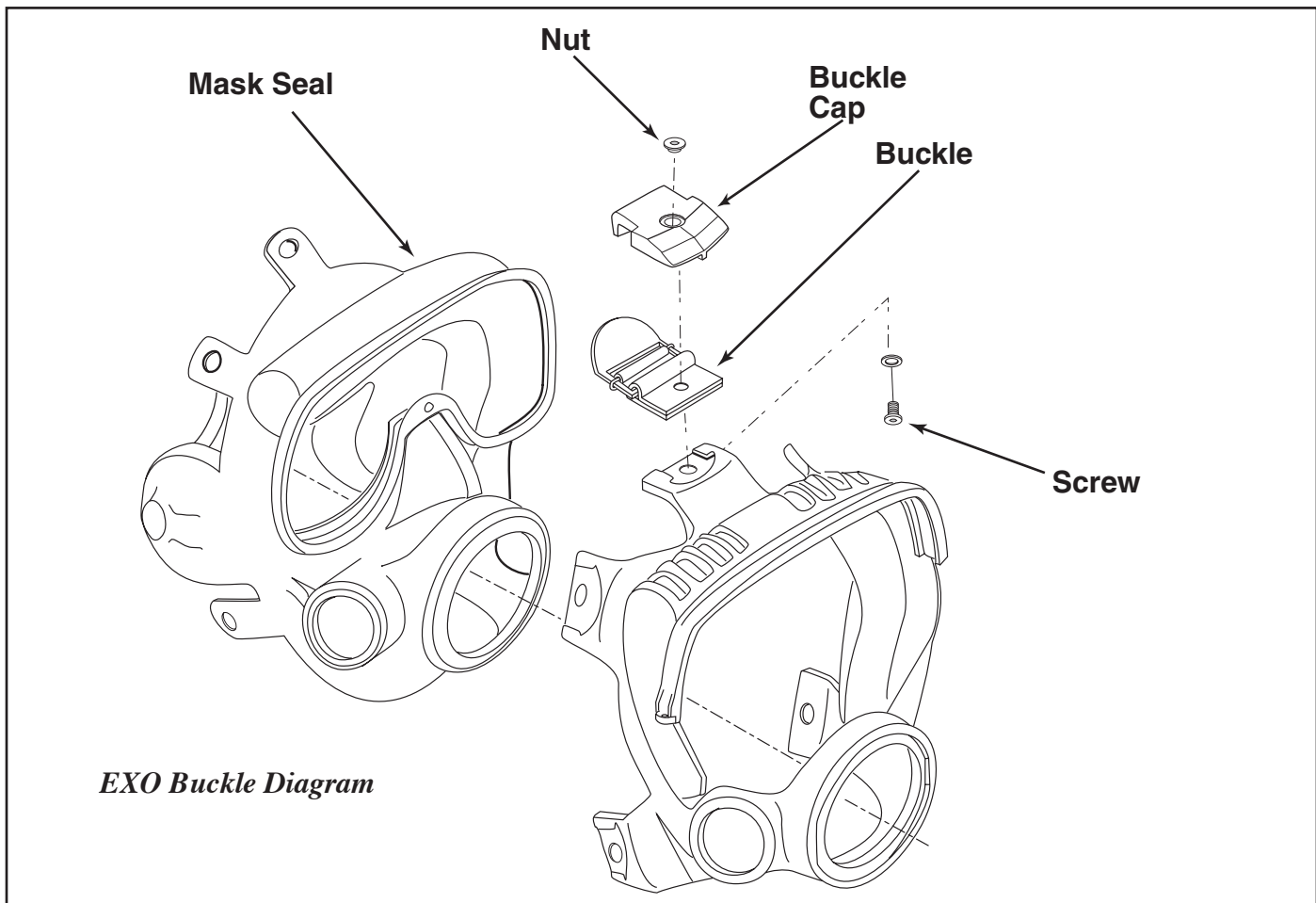



Lightly lubricate the screw hole on the spider tab.



Insert the screw through the mask frame.

5) Place an Allen screw with a washer on it onto the shortened leg of the 1/8" Allen wrench.

6) Take one entire assembly of "T" nut, buckle cap, and buckle and press the end of the "T" nut through the hole on the back side of one of the tabs on the mask



Use a 3/16" Allen wrench to tighten the "T" nuts.

seal, then through the mask frame. Insert the 3/16" Allen wrench in the "T" nut and hold the assembly in place on the frame.

7) Take the Allen screw with a washer on it on the 1/8" Allen wrench and hold it up against the back side of the "T" nut. Turning the 3/16" Allen wrench and the "T" nut, thread the screw into the "T" nut. Tighten the screw and "T" nut. Once again make sure that the washer is correctly positioned on the "T" nut and that it is not captured.

8) Repeat steps 3 thru 7 for all the buckle assemblies.

6.4 Replacing the Face Seal or Frame

The face seal should be inspected prior to every dive to check for punctures, tears or signs of cracking. A torn or cracked face seal may cause the mask to free flow and/or flood. If the face seal is damaged, it must be replaced. This can be a difficult procedure.

It is recommended that this procedure be done by a factory trained KMDSI dealer. If you are going to attempt this procedure, **read and understand all previous sections of this chapter before you start.** The EXO Tool Kit, Deluxe KMDSI Part #325-650 is required to do this procedure.

Tools Required:

3/16 inch Allen wrench, 1/8 inch Allen wrench, EXO Tool Kit, Deluxe

6.4.1 Face Seal Removal

- 1) If you are using communications, remove the communications module, microphone and earphones. See the chapter on communications.
- 2) Release the spider from the buckles and remove.
- 3) Remove the regulator assembly, per this chapter.
- 4) Remove the lens, per this chapter.
- 5) Remove the buckles and buckle caps, per this chapter.
- 6) Separate the mask seal from the mask frame.

6.4.2 Face Seal Installation

- 1) Put the mask seal into the frame. Seat the lens seal area of the mask seal into the upper lens clamp part of the frame. Seat the regulator and comm module areas of the mask seal in the correct spots on the frame.
- 2) Install the regulator assembly, per this chapter.
- 3) Install the lens, per this chapter.
- 4) Install the buckles and spider, per this chapter.
- 5) Install the communications module. See Chapter 7.

Chapter 7 Communications

The EXO may be ordered either with no comms or with one of three different communications modules. They are: **Binding Posts** for bare wire connection, **Waterproof Connectors** for hard wire communications, and **Wireless** communications.

In surface supplied diving the most commonly used types of connectors are the binding posts and the waterproof connectors. Waterproof connectors provide better communications. In addition, if you are diving in salt water, waterproof connectors will extend the life of the communications wire in your umbilical.

7.1 Bare Wire Binding Posts

To connect bare wires to binding posts, be sure you have a sufficient length of clean, bare wire exposed. If the wire is covered with corrosion clean it until the shiny wire is exposed or cut it back and expose new wire.

1) Twist the wire strands in each individual wire until



Communications module with microphone cup for original EXO.



Communications module with cap for EXO BR.

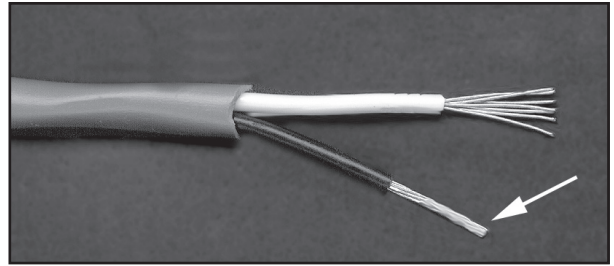

Coat with a thin coat of solder to prevent fraying.

they are wound tightly together. Coat these with a thin coat of solder to prevent fraying.

2) Unscrew each of the binding post nuts until the hole in the shaft of the post is exposed.

3) Insert one soldered wire into each of the holes in the binding posts. The wires should stick out of the hole of each post, but should not touch each other. If the wires touch, you will create a “short” and there will be no communications between the diver’s mask and the top side communication box.

4) Tighten each of the binding post nuts until snug. Do not overtighten.

5) Test the communications system and ensure that it is in proper working order.

7.2 Waterproof Connector (WPC)

Waterproof connectors are a little more expensive than bare wire posts, but they provide better communications, the possibility of a 4 wire system, and will extend the life of the diver’s umbilical communications wire. Salt water entering the bare wire system will lead to corrosion of the wires and possible failure of the system.

Waterproof connectors are rugged but require a bit more care in handling than binding post connectors. If you are careless in handling a waterproof connector

you may cause it to fail and they can not be repaired. Most waterproof connector manufacturers recommend that you lubricate the connections using silicone grease.

- 1) To connect the male and female portions of the waterproof connectors, align the key on the male connector with the yellow mark on the female connector.
- 2) Press the two connectors together until you hear a



EXO STANDARD or BR Module Assembly With Waterproof Connector

distinct “pop”, which is the air escaping from between the two connectors, creating a seal.

- 3) Tape the two connectors with a bit of electrical tape to prevent them from pulling apart.
- 4) Test the communications system and ensure that it is in proper working order.

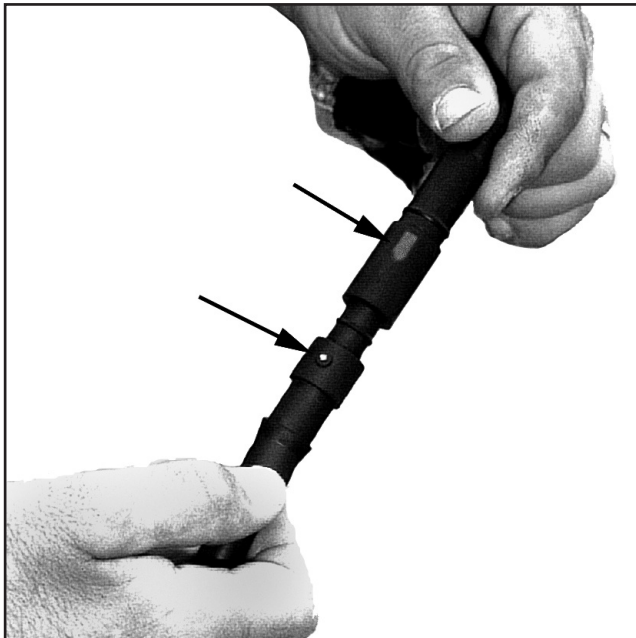

Align the key on the male connector with the yellow mark on the female connector.



The communications system should always be tested prior to the diver entering the water.

7.3 Wireless Communications

The EXO mask may also be used with wireless communications. There are several manufactures of these units, OTS (Ocean Technology Systems) and DiveLink, just to name a few. Read and follow the manufacturers' instructions for these units.

Wireless systems are usually only employed by free swimming SCUBA divers. Wireless systems allow the diver to swim unrestricted by any lines or tethers. However, if you are using the EXO in the surface supplied mode it is usually more effective and reliable to use a hard wire system.

Wireless systems are used in many different types of diving. Some examples include search and rescue, re-search diving, and SCUBA instruction. With a wireless system it is possible to communicate both diver-to-diver and/or diver-to-surface.

The communications system should always be tested and any problems solved or adjustments made prior to the diver entering the water. Procedures may vary between the makers of the top side communication boxes. Follow the manufacturer's instructions on how to test these units.



WARNING

The waterproof case for your wireless communications unit should only be attached to your scuba backpack, never to your weight belt. In the event your belt must be dropped the belt must have a clear drop path and must not be connected to any other piece of gear.

If this procedure is not followed the weight belt and wireless electronics case will be attached to the mask by the connecting wire. This could lead to drowning.



Wireless communications are strongly recommended whenever you are diving in the scuba mode with a full-face mask.

7.4 Removing the Communications Module

After each day of diving, the entire mask communications system should be removed, cleaned, and allowed to dry.

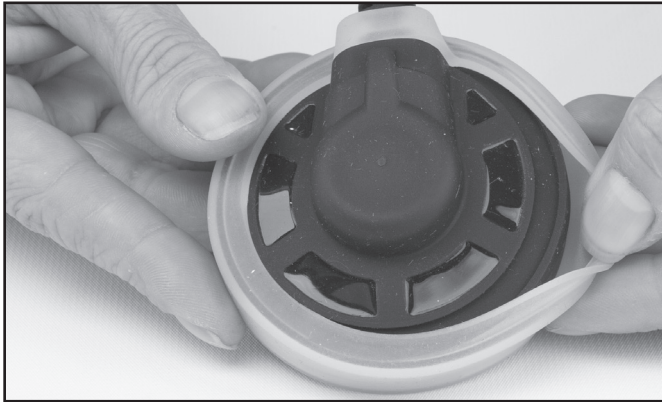

Remove the outer earphone covers and allow all the parts to dry.

- 1) First remove the communications mounting ring by unscrewing it.
- 2) Reach inside each earphone pocket, grasp the earphone and remove it.

! CAUTION

Do not remove the earphones by pulling on the wires. This may damage their interior connections.

! CAUTION

Do not apply any pressure to either the penetrator, or the communications posts, for removal. This could possibly damage the unit.

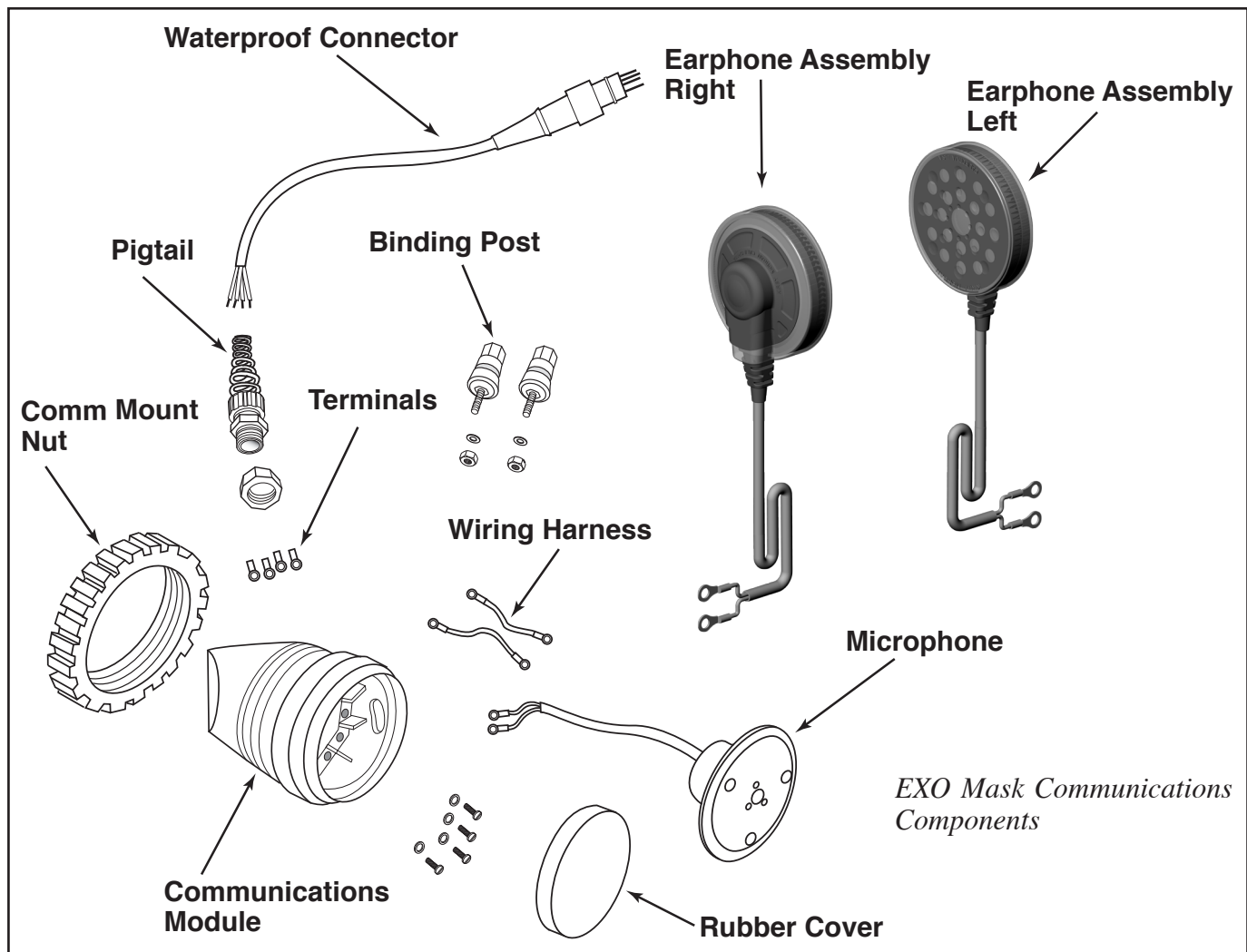

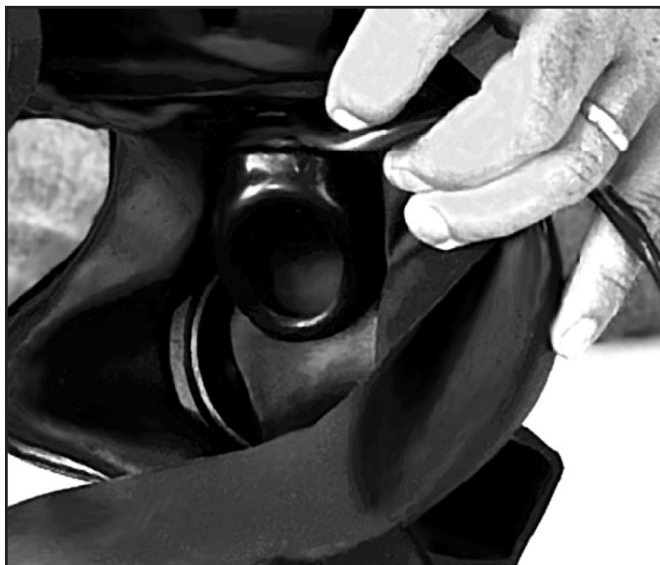

Make sure the microphone cup in the EXO Original is positioned correctly.

3) In the EXO Standard or Balanced remove the microphone from the oral nasal. Once again do not pull on the wire as this can damage the connection.

4) The entire communications assembly can now be separated from the mask. The module should be pushed to the inside of the mask by applying pressure to the flat angle area on the exterior of the comm module.

5) Remove the outer earphone covers, and on the EXO Original the microphone cup, and allow all the parts to dry.

7.5 Installing the Communications Module

If you are installing communications into a mask that did not originally come with communications, the back side of the microphone cup on the oral nasal may need to be trimmed out. If it is the newer version, simply remove the plastic plug.

1) Ensure that the mask seal is correctly seated in the frame. This is very important as the mask seal also acts as the seal for the communications module.

2) Reassemble the earphone covers and the microphone cup (EXO Original).

3) If the comm module is equipped with a waterproof connector, insert the waterproof connector back through the mask seal and frame from the inside of the mask

4) Work the comm module into the mask seal from the inside until it is properly positioned and seated.

On the EXO original, make sure the microphone cup is positioned correctly.

5) Screw the comm module mount nut back onto the comm module and tighten.

6) Insert the earphones in their pockets. Using a pump spray type of silicone, a light coat on the outside of the earphone covers helps the earphone assembly to slide into the pocket easier.

7) Tuck any excess wires behind the edge of the mask seal.

! CAUTION

Avoid spraying aerosolized silicone spray on any of the plastic parts of the mask. Certain chemicals used to propel silicone spray from the can may damage the plastic components of the mask. Use silicone in a bottle with a manual pump or a very light application of silicone grease.

8) Mount the microphone back into the oral nasal (EXO Standard or BR).

9) Test to ensure that the communications module is in proper working order.

10) Masks not using communications systems should be fitted with an oral nasal microphone cup plug. KMDSI oral nasal plug, part # 320-001 is available for this purpose.

7.6 Earphone and/or Microphone Removal

- 1) Remove the communications assembly from the mask.
- 2) Remove the comm module cover (EXO Standard or EXO BR).
- 3) Using a small flat blade screwdriver, carefully scrape out the waterproof coating in the slots of the screws in the comm module and remove the screws and washers. **Take note of where all the wires are connected, it will help when reassembling the unit.**
- 4) Carefully remove the wires from the module.

7.7 Earphone and/or Microphone Installation

- 1) Test the assembly, earphone or microphone, to ensure that your components are functioning properly before installation into the comm module.
- 2) Insert the wires into the comm module one at a time in the correct order (see above).
- 3) Use the correct wiring diagram at the end of this chapter for your communications set up to recon-

nect the wires into the comm module using the screws and washers.

- 4) Test the communication assembly.
- 5) Once the comm assembly has been tested and is in working order, paint a light coat of RTV silicone sealant onto the screws, washers, and terminals to waterproof them.
- 6) Reinstall the comm module cover (EXO Standard or EXO BR).

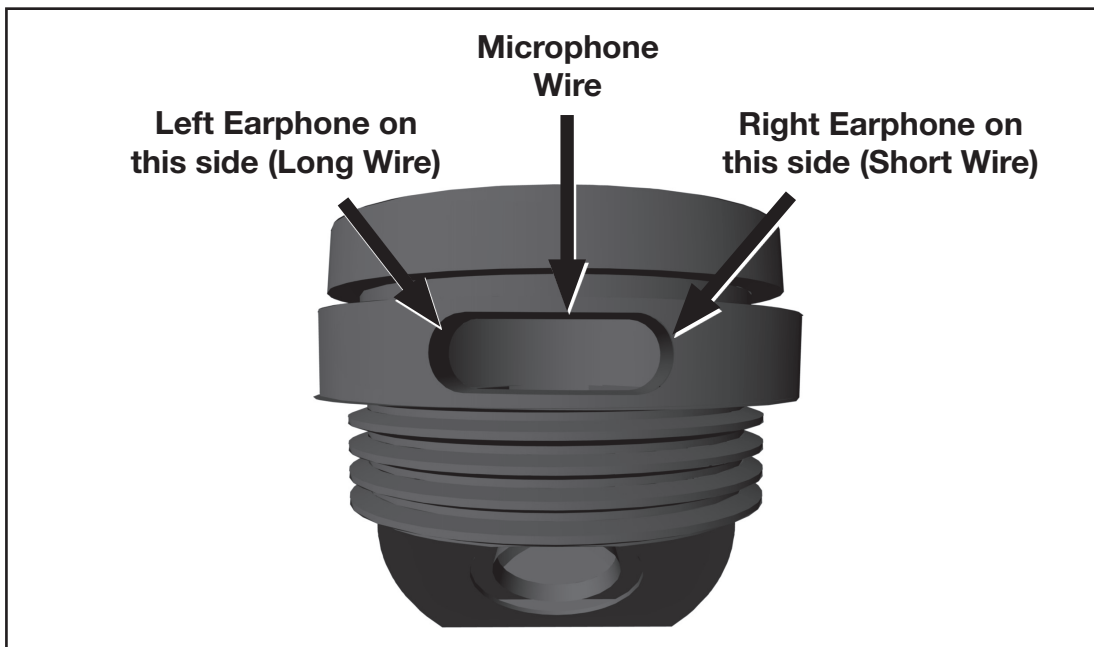

Insert the wires into the comm module one at a time in the correct order

7.8 Removing the Waterproof Connector (WPC)

- 1) Remove the communications assembly from the mask.
- 2) Remove the comm module cover (EXO Standard or EXO BR).
- 3) Remove the earphones and microphone connections from the comm module.
- 4) The WPC mount nut on the inside of the comm module should be held so that it won't turn. Use a 3/4" open end wrench on the exterior WPC packing and unscrew the WPC assembly from the comm module.
- 5) Remove the WPC mount nut from inside the comm module.

7.9 Installing the Waterproof Connector (WPC)

- 1) Put a small bead of RTV silicone sealant around the top part of the threads on the WPC packing where it rests against the comm module to form a seal between the WPC and the comm module.
- 2) Put the WPC mount nut in the comm module and hold it up against the hole in the comm module.
- 3) Feed the wires from the WPC through the hole in the module and through WPC mount nut. Screw the WPC assembly into the comm module and tighten. Clean any excess RTV from around the WPC packing.
- 4) Feed the earphone and microphone wires into the comm module. Make sure they are in the right order. (Fig. 6.)
- 5) Follow the appropriate wiring diagram and reconnect the wires.
- 6) Test the communication assembly.
- 7) Once the comm assembly has been tested and is in working order, paint a light coat of RTV silicone sealant onto the screws, washers, and terminals to waterproof them.
- 8) Reinstall the comm module cover (EXO Standard or EXO BR).

7.10 Removing the Binding Posts

- 1) Remove the communications assembly from the mask.
- 2) Remove the comm module cover.
- 3) Remove the earphones and microphone from the comm module. **Take note of where all the wires are connected. This will help when reassembling the unit.**



Use a metal pick or a small stiff piece of wire inserted in the binding post to keep it from spinning.

- 4) Use a metal pick or a small stiff piece of wire and insert it through the wire connection hole in the binding post. This will help you hold on the post and either spin it or keep it from spinning. Also, use a 3/8" open end wrench on the binding post mounting nuts on the inside of the module and unscrew the binding posts.
- 5) Remove the nuts, washers, and wire harnesses from the inside of the comm module. **Take note of where all the wires are connected, it will help when reassembling the unit.**

7.11 Installing the Binding Posts

- 1) Put a bead of RTV silicone sealant around the bottom of the threads and on the bottom of the binding post body.
- 2) Insert the binding post into one of the holes in the comm module.
- 3) Put one end of the wire harness on the end of the post, followed by the washer, and nut. Tighten the binding post into the comm module. Repeat for the other post.

- 4) Feed the earphone and microphone wires into the comm module. Make sure they are in the right order. Refer to the Installing the Earphone and Microphone section of this chapter.
- 5) Follow the appropriate wiring diagram to reconnect the wires.
- 6) Test the communication assembly.
- 7) Once the comm assembly has been tested and is in working order, paint a light coat of RTV silicone sealant onto the screws, washers, and terminals to waterproof them.
- 8) Reinstall the comm module cover (EXO Standard or EXO BR).

7.12 Waterproof Connector (WPC) Assembly Rebuild

- 1) Remove the waterproof connector (WPC) assembly from the comm module.
- 2) Cut off the terminals or "sweat" them off with a soldering iron if you are going to reuse them.
- 3) Unscrew the packing gland from the pigtail nut. Take off the packing gland, rubber seal, packing washer and pigtail nut. Note the position of the rubber seal and the packing washer and the directions that they face.
- 4) Discard the old WPC.
- 5) On new WPC's the black casing may need to be stripped back 1 1/4" from the end of the wires. The tips of the wires usually come already stripped and dipped in solder. If not, strip the end of the wires 1/4" and solder the ends to prevent fraying.
- 6) Lightly grease 2 " of the black casing with silicone grease to help slide the pigtail nut on. Slide the pigtail nut on, making sure it faces in the correct direction.
- 7) Position the packing washer 2 1/4" from the end of the wires and facing in the correct direction. Put the rubber seal on also facing in the correct direction and slide it up against the packing washer.
- 8) Slide the packing gland on up against the rubber seal, making sure it is facing in the correct direction. Try not to move the position of the packing washer.
- 9) Screw the packing glands and pigtail nut together and tighten.

10) Solder terminals on to the end of the wires.

11) Test WPC assembly with a multi-meter if possible to ensure that all connections are good. Reinstall WPC assembly in comm module, per this chapter.

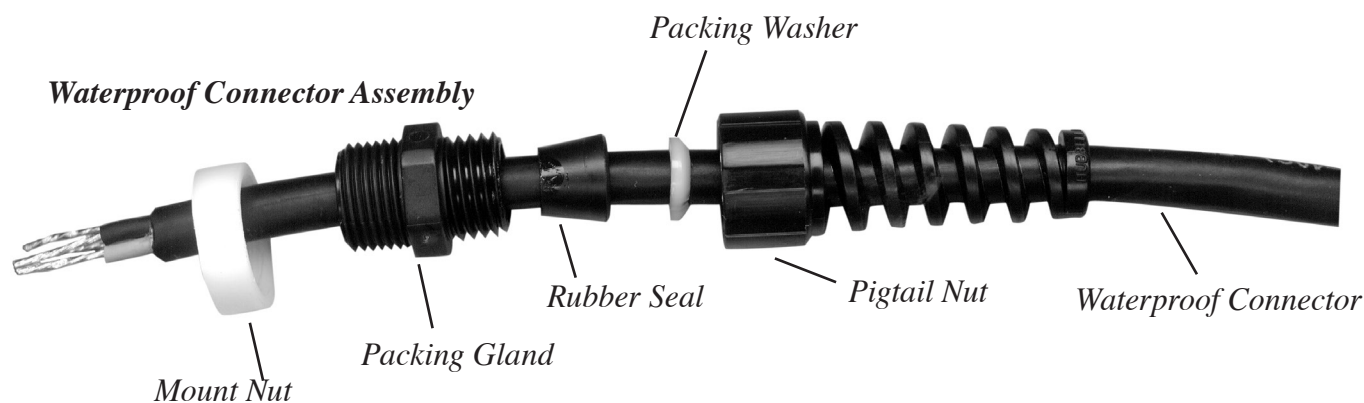

7.13 Waterproof Connector (WPC) Pin Diagrams

The view in these diagrams is looking straight at the pins on the WPC. The large pin is at the top.

7.14 Post Dive Maintenance

If your mask is equipped with any type of communications, post dive maintenance on the mask and communications module must be done after each days dive. The post dive procedures may vary between manufacturers, depending on which communication module you are using. Follow the manufacturers instructions on post dive maintenance. The following is the recommended post dive maintenance procedures for the KMDSI communications modules.

- 1) Remove the communications from the mask.
- 2) Lightly rinse the assembly with fresh clean water. Do not immerse the entire assembly under water and try to keep the water out of the earphone covers and from under the module cover. The microphone can get wet.
- 3) Dry the assembly off. Open the earphone covers and take the module cover off and let everything dry on the inside.
- 4) Once everything is dry, reassemble the earphone covers and reinstall the module cover.

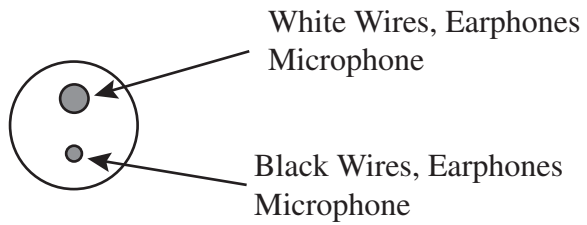

2 Pin Waterproof Connector

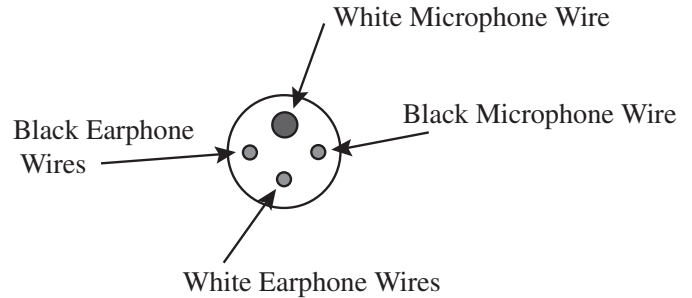

4 Pin Waterproof Connector

Communications Module Assembly Wiring Diagrams

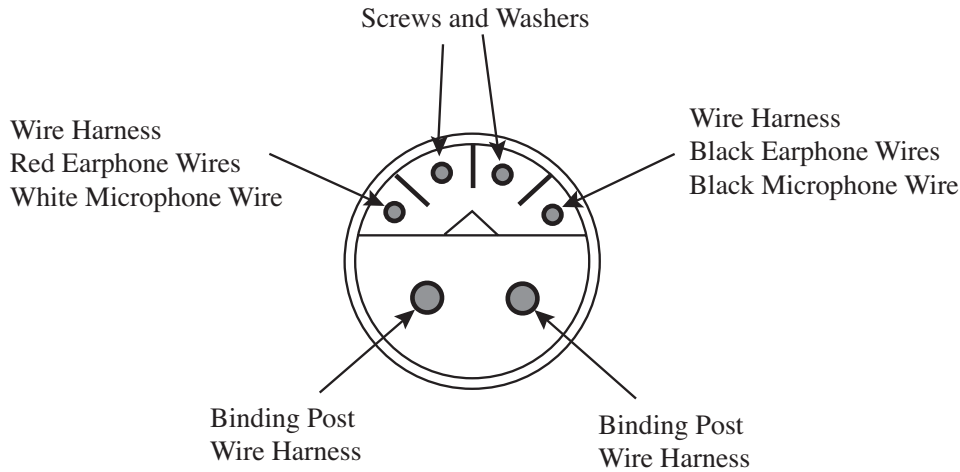

Binding Posts

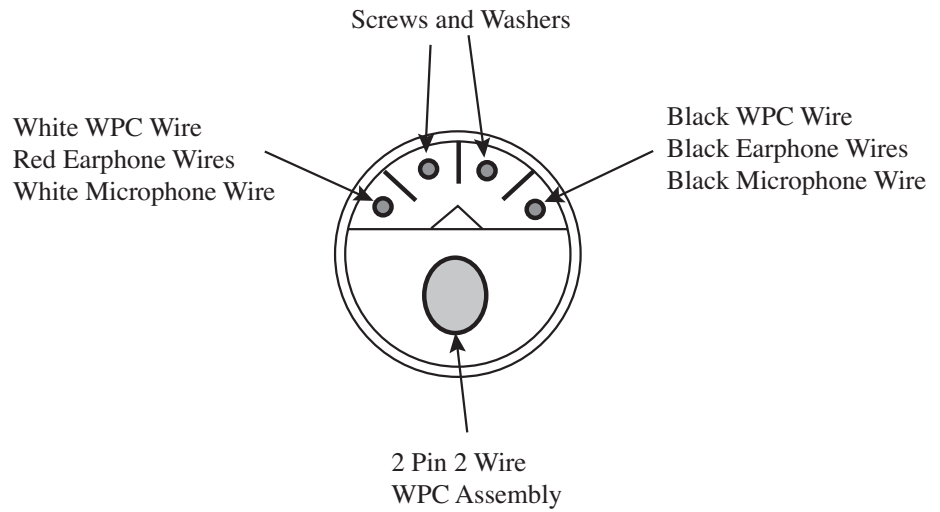

2 Pin 2 Wire, Waterproof Connector (WPC)

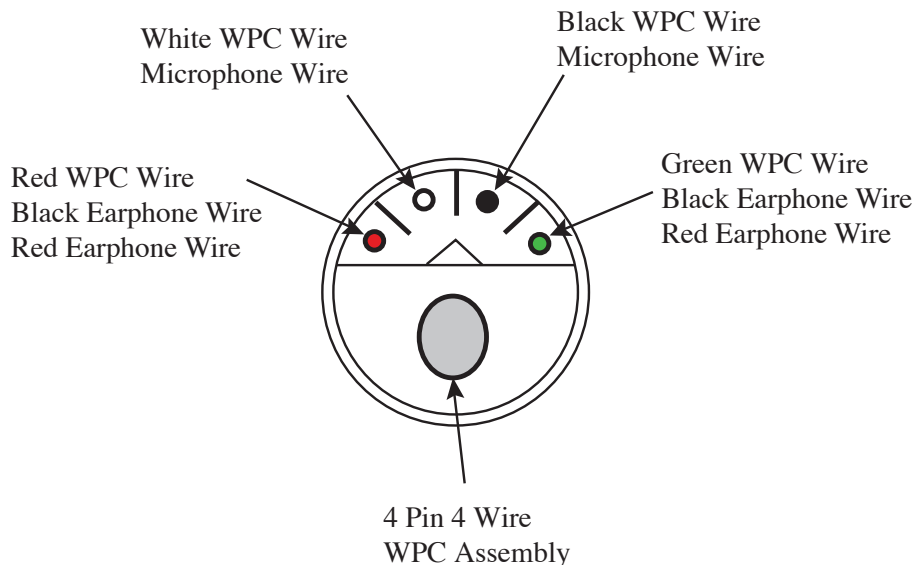

4 Pin 4 Wire, Waterproof Connector (WPC)

Appendix

Breathing Gas Requirements

EXO Balance Regulator Full-Face Mask

If you have any questions regarding proper set-up, operation, or maintenance of your Kirby Morgan mask contact KMDSI (850) 928-7772 or at kmksi@KirbyMorgan.com or Dive Lab Inc. (850) 235-2715 or at Divelab@aol.com. There are also detailed checklists for the set-up and maintenance of your mask on the Dive Lab web site at www.divelab.com.

8.2 Regulator Performance

8.2.1 EXO-BR® Regulator

The EXO-BR® regulator on the EXO Full-Face Mask offers high performance. The regulator has been tested at Dive Lab at Panama City, Florida. It meets or exceeds all current U.S. Navy and European diving standards.

8.2.2 Minimum Operating Temperature

The minimum operating temperature recommended for this regulator for surface supplied diving is 33 degrees F (~1°C) and for scuba is 37 degrees F (~3°C), only in regards to regulator performance. At the time of this writing, no hot water shroud is available for this mask for heating the diver's breathing gas

⚠ WARNING

Diving in cold water, i.e., at temperatures below 50 degrees F (10°C), may subject the diver to severe respiratory heat loss. This may lead to a decrease in body core temperature also known as "hypothermia." Hypothermia is extremely dangerous and can lead to a loss of reasoning ability, decreased manual dexterity, uncontrollable shivering, unconsciousness, and death.

8.3 Cage Code

The cage code for identifying KMDSI products for U.S. government purposes is 58366.

8.4 CR Standards

These masks meet or exceeds all standards established by Dive Lab of Panama City, Florida, and is CR (Commercially Rated) marked.



8.5 CE Approved

The EXO-BR is CE Approved.



8.5.1 CE Approved

The EXO Full Face Mask has been tested and conforms to the performance requirements as set forth in Annex II of Directive 89/686/EEC and, as far as applicable, the EN 15333-1 (Class C).

It is fully CE marked with demand regulator EXO-26 BR_Balanced Regulator (1st stage pn 305-161 and 2nd stage pn 305-040).

Category of PPE: III

⚠ WARNING

The EXO Full Face Mask has been tested with air and CE certificates for use with air up to 50 meters. Compressed air must be compliant with the EN 12021.

All the tables reporting the technical data and the pressure of use are relative to compressed air.

8.5.2 Notifying Body

The Notifying Body is Eurofins Product Testing Italy Srl

Address: Via Courgné,
21-10156 Torino,
ITALY

Identification number: 0477

8.5.3 Notifying Body

In the mark the data reported are the following:



1. The name and the address of the manufacturer;
2. Harmonized reference standard: EN 15333-1;
3. CLASS C = NO protection;
4. PPE model;
5. Serial number (laser etched on the EXO Full Face Mask frame);
6. CE marking: **CE**;
7. Notifying Body number.

⚠ DANGER

Decompression diving always involves the risk of decompression sickness. Omitted decompression due to a loss of the breathing gas supply or other accidents can cause serious injury or death. Use of a Kirby Morgan helmet or mask cannot prevent this type of injury.

⚠ CAUTION

The user cannot:

- Remove the mark from the BR regulator;
- Modify or counterfeit the data reported on the mark.

⚠ CAUTION

The mark shall be visible and legible throughout the life of the PPE. If the mark deteriorates or is not legible the user should contact the manufacturer.

8.6 Operational Specifications & Limitations for Surface-Supplied Diving

-Umbilical minimum I.D. 3/8" (9.5 mm) of not more than two sections, total length not to exceed 600 feet (183m).

This mask meets or exceeds all requirements of NPD, HSE (UK), US Navy and US Coast Guard. It is CE certified and CR rated by Dive Lab, Panama City, FL, USA.

Work Rate Expressed as Respiratory Minute Volume (RMV)*			
Work Load	RMV	Cubic Feet/Minute (CFM)	Equivalent Land Based Exercise
Rest	7-10 RMV	0.2 - 0.35 CFM	
Light Work	10-20 RMV	0.35 - 0.7 CFM	Walking 2 miles per hour
Moderate Work	20-37 RMV	0.7 - 1.3 CFM	Walking 4 miles per hour
Heavy Work	37-54 RMV	1.3 - 1.9 CFM	Running 8 miles per hour
Severe Work	55-100 RMV	1.94 - 3.5 CFM	

* source: U.S. Navy Diving Manual

8.6.1 Using the EXO-BR Regulator with a Low Pressure Compressor Supply

The EXO-BR Regulator Low Pressure Compressor Supply Pressure Requirements table in this manual are designed to assist you in selecting the proper compressor for the depths at which you plan to work and for the work load at which you will be working. In physiological terms, work load is normally defined in terms of exercise rate. Exercise rate is normally determined by heart rate and may also be defined by your breathing rate. The higher your heart rate and the higher your rate of breathing, the harder you are working. For a highly fit diver, the limiting factor in how hard you can work underwater is how much breathing gas your mask will supply.

For practical purposes, the U.S. Navy defines breathing work rates in terms of “RMV” which stands for Respiratory Minute Volume.” RMV is defined as the amount of breathing gas that flows in and out of your lungs in one minute.

Users should ensure that the compressor or supply system meets both the supply pressure and output volume required for the deepest anticipated depth and ventilation rate. Below is the formula used for computing the volume of air being used at a given ventilation rate at depth.

Note: This is the bare minimum. As a safety margin, it is best to plan on an additional 10%-20% of breathing gas to ensure the supply system can keep up.

$\{(Depth + 33) \div 33\} \times RMV\} \times .10$ or $.20$ safety margin.

Best Practice:

- When using a LP compressor always base the output pressure on the lowest pressure during compressor cycling.
- Complete a flow test of the compressor / air system and all umbilicals at least once a year and/or whenever in doubt as to the capability.
- Always take the standby diver into consideration when planning air usage.
- Always allow for at least 10-20% greater volume than what is needed for the maximum ventilation anticipated.
- Never use less than 40 RMV for planning purposes.
- Always dive with a fully functional man worn emergency gas supply system (EGS) of sufficient capacity based on the hazards of the task, have the cylinder valve open and the emergency valve shut.

- When using HP supply systems (Control Consoles) use the recommended pressures for depth as listed in the table for High Pressure Regulators Settings found in this chapter. For best overall performance avoid using pressures excessively higher than what is required for depth especially if diving shallow.

If using umbilicals longer than 600 feet, or umbilicals with an internal diameter less than 3/8” (9.5mm), or other configurations not mentioned, E-mail or call KMDSI or Dive Lab, Inc., for further guidance and information.

8.6.2 Using the EXO-BR Regulator Low-Pressure Compressor Supply Pressure Requirements Table

⚠ WARNING

The EXO-BR Regulator® Low-Pressure Compressor Supply Pressure Requirements tables presented in this manual are intended for use with properly adjusted and maintained KMDSI® EXO Balanced Regulator Full-Face masks only. None of the KMDSI® supply tables have been evaluated on other makes of masks and should not be used with other manufacturers’ helmets or masks.

⚠ WARNING

To properly supply the diver with breathing air, the mask as well as the umbilical and associated supply system must be properly configured, maintained, and adjusted.

To use this table, you must know your compressor’s maximum pressure output, the diver’s maximum planned depth, the volume of gas the compressor is capable of pumping, and the diver’s anticipated work load. These tables are **NOT** designed for use with the Kirby Morgan SuperFlow 350 or 450 regulators.

SCFM stands for “Standard Cubic Feet Per Minute” and is a measure of the volume of air the compressor delivers. This measurement is made at sea level. SLPM is an abbreviation for Standard Liters Per Minute and is the metric equivalent of SCFM.

Example #1: You are using a 5120 compressor with a maximum output pressure of 200 p.s.i.g. A Quincy 5120 compressor is designed to deliver 88.5 cubic feet of free air at 200 p.s.i.

You know you will be doing a long job,

positioning sand bags for a pipeline crossing at a depth of 160 FSW. Look in the table at the left hand column and find the maximum pressure output for your compressor, i.e, 200 p.s.i. You will see that at 200 p.s.i.g. the compressor will supply sufficient air to maintain 40 RMV at depths down to 220 FSW, with a sufficient volume of air.

Example #2: You plan to use a 325 compressor with a maximum output pressure of 150 p.s.i.g. A Quincy 325 delivers 19.20 cubic feet of free air at 150 p.s.i. To carry sandbags for a pipeline crossing at a depth of 160 FSW, although the 325 would provide sufficient air for the diver to perform work at 40 RMV, it would not provide the recommended safety margin of 10%-20%. If your work load increased to 50 RMV, the compressor would not be sufficient to support that work load and would leave you feeling starved for air.

Remember that if a decompression chamber is on the same circuit as the diver, the diver will be starved for air if the chamber is blown down while the diver is in the water. Whenever possible, there should be at least one air source devoted to diving operations and a separate air source used solely to operate the decompression chamber.

Once the diver begins to consume air faster than the compressor can supply it, the diver will feel starved for air. This is a very dangerous situation underwater.

WARNING

It is important for the user/diver to take excessive currents into consideration. The exhaust system on the EXO-BR® Regulator will help prevent water intrusion when diving in heavy currents. The EXO-BR® exhaust system does not limit the diving depth.

The umbilical assembly should be composed of good quality diving hose that meets industry standards. Generally, gas hose will be married to the communications wire, pneumofathometer hose, and strength member in a manner that will allow the strength member to receive all the strain.

There are also good quality umbilicals available that are assembled at the factory using a twisted method which does not require marrying. Regardless of the system used, the umbilical is the diver's life line and should always be of excellent quality and maintained carefully.

EXO-BR Regulator® Low-Pressure Compressor Supply Pressure Requirements Table*					
Supply Pressure Surface Gauge Reading	RMV (Respiratory Minute Volume)	Maximum Recommended Depth		Required SCFM**	Required SLPM**
		FSW	MSW		
90 P.S.I.G. (6.21 BAR)	40 (heavy work)	104	32	7.0	198
	50 (heavy work)	76	23	7.0	198
	62.5 (severe work)	61	18.8	7.5	212
	75 (severe work)	50	15.4	8.0	227
100 P.S.I.G. (6.9 BAR)	40 (heavy work)	108	33	7.25	205
	50 (heavy work)	90	27	7.9	223
	62.5 (severe work)	75	22.9	8.7	246
	75 (severe work)	59	18	8.9	252
110 P.S.I.G. (7.59 BAR)	40 (heavy work)	117	35	7.7	218
	50 (heavy work)	100	30	8.6	244
	62.5 (severe work)	83	25	9.3	263
	75 (severe work)	68	21	9.7	275
120 P.S.I.G. (8.28 BAR)	40 (heavy work)	127	38.7	8.2	232
	50 (heavy work)	113	34	9.4	266
	62.5 (severe work)	93	28	10	283
	75 (severe work)	75	23	9.7	275
130 P.S.I.G. (8.97 BAR)	40 (heavy work)	145	44	9.1	258
	50 (heavy work)	125	38	10	283
	62.5 (severe work)	106	32	11	311
	75 (severe work)	85	26	11.36	322
140 P.S.I.G. (9.66 BAR)	40 (heavy work)	160	48	10	283
	50 (heavy work)	135	41	11	311
	62.5 (severe work)	114	35	12	340
	75 (severe work)	92.5	29	12	340
150 P.S.I.G. (10.35 BAR)	40 (heavy work)	170	52	10.5	297
	50 (heavy work)	149	45	11.7	331
	62.5 (severe work)	126	38	13	368
	75 (severe work)	105	32	13.3	377

The above values were derived from actual breathing simulator tests using an ANSTI wet simulator with 600' long umbilical 3/8" I.D (9.5mm) at Dive Lab, Inc. The respiratory work rates and test procedures used are based on internationally recognized test practices and procedures.

** includes a 20% safety factor

Note: Most sustained work rates by professional divers average between 20 to 40 RMV. When calculating supply requirements, KMDSI® recommends using no less than 40 RMV.

EXO-BR Regulator® Low-Pressure Compressor Supply Pressure Requirements Table*					
Supply Pressure Surface Gauge Reading	RMV (Respiratory Minute Volume)	Maximum Recommended Depth		Required SCFM**	Required SLPM**
		FSW	MSW		
160 P.S.I.G. (11.04 BAR)	40 (heavy work)	186	57	11.3	320
	50 (heavy work)	157	48	12.2	345
	62.5 (severe work)	134	41	13.4	379
	75 (severe work)	112	34	14	396
170 P.S.I.G. (11.73 BAR)	40 (heavy work)	203	62	12.2	345
	50 (heavy work)	170	52	13	368
	62.5 (severe work)	143	43	14	396
	75 (severe work)	121	37	14.9	422
180 P.S.I.G. (12.42 BAR)	40 (heavy work)	219	67	13	368
	50 (heavy work)	180	55	13.7	388
	62.5 (severe work)	158	48	15.4	436
	75 (severe work)	130	39	15.7	445
190 P.S.I.G. (13.11 BAR)	40 (heavy work)	220	67	13	368
	50 (heavy work)	192	58	14.5	411
	62.5 (severe work)	165	50	16	453
	75 (severe work)	141	43	16.8	476
200 P.S.I.G. (13.80 BAR)	40 (heavy work)	220	67	13	368
	50 (heavy work)	205	62	15.3	433
	62.5 (severe work)	174	53	16.7	473
	75 (severe work)	147	45	17.4	493
210 P.S.I.G. (14.49 BAR)	40 (heavy work)	220	67	13	368
	50 (heavy work)	214	65.8	16	453
	62.5 (severe work)	186	56	17.6	498
	75 (severe work)	159	48	18.5	524
220 P.S.I.G. (15.18 BAR)	40 (heavy work)	220	67	13	368
	50 (heavy work)	220	67	16.3	462
	62.5 (severe work)	194	59	18.2	515
	75 (severe work)	165	50	19	538

The above values were derived from actual breathing simulator tests using an ANSTI wet simulator with 600' long umbilical 3/8" I.D (9.5mm) at Dive Lab, Inc. The respiratory work rates and test procedures used are based on internationally recognized test practices and procedures.

Note: Most sustained work rates by professional divers average between 20 to 40 RMV. When calculating supply requirements, KMDSI® recommends using no less than 40 RMV. For more information, check the Dive Lab website, www.divelab.com

8.6.3 Using a High-Pressure Breathing Gas Supply

High pressure (HP) control consoles are capable of supplying air or mix gas at pressures and volumes much greater than low pressure air compressors, and are often preferred by military and scientific divers. HP air systems are often used as back up supply for LP compressor diving.

When using HP air or mix gas systems, The regulator is normally loaded to 100-150 psig on the surface and increased to the bottom setting as the diver descends or when the diver reaches the bottom. During ascent the pressure is reduced to between 100-150 p.s.i.g. once the diver is shallower than 100 feet. A high-pressure gas supply is typically used under the following conditions:

- When the work load exceeds the capabilities of the compressor to supply a sufficient volume and pressure of breathing gas, regardless of the depth.
- When the diver is using pre-mixed gas.
- As a back-up for a low-pressure compressor
- Any time a high-pressure supply is available

The regulator is loaded as the diver increasingly descends and unloaded as the diver returns to the surface. If the diver experiences a free-flow with his regulator, when the bias adjustment knob is properly set and the regulator has been maintained correctly, the pressure setting on the high-pressure regulator setting may be too high and may need to be decreased.

The following table provides recommended pressures when using a high-pressure breathing gas supply and dome loaded regulator. Generally speaking, the topside regulator should be set at 140 p.s.i.g. over bottom pressure for optimum regulator performance.

Topside High-Pressure Regulator Settings for use with the Kirby Morgan EXO-BR Regulator®					
Depth		Regulator Setting P.S.I.G.		Regulator Setting BAR	
FSW	MSW	Optimum P.S.I.G.	Maximum P.S.I.G.	Optimum BAR	Maximum BAR
0-60	0-18	140	200	9.7	13.8
61-100	19-30	165	220	11.4	15
101-132	31-40	190	250	13	17
133-165	41-50	275	300	19	20.7
166-220	51-61	300	320	20.7	22

⚠ WARNING



The demand regulator and side block assemblies have a maximum design pressure of 225 p.s.i.g. (15.5 bar) over-bottom. Higher pressures could lead to component failure and serious personal injury.

⚠ WARNING

Gas systems used to supply Kirby Morgan helmets and masks must be capable of supplying gas to the diver at the required pressure and flow rates as stated in the operational specifications. The use of unregulated gas sources is extremely dangerous.

The use of standard SCUBA type regulators is unacceptable, as there are no provisions for adjusting the intermediate pressure to the diver. Only proven systems that allow for varying the gas supply pressure to the diver should be used for umbilical diving.

⚠ WARNING

When the EXO FULL FACE MASK is used for air diving in countries that conform to CE regulations, it shall be used to a maximum depth of 164 fsw (50msw) I.A.W. EN15333-1.

Appendix II

EXO Full-Face Mask Transport And Storage

9.1 Helmet Transport And Storage

- The kind of package for one EXO[®] FFM is a cardboard box with cardboard inserts to stabilize the EXO[®] FFM
- The kind of packaging for two EXO[®] FFMs is a cardboard box with air filled pillows to stabilize the EXO[®] FFM;

The weight of the box is usually:

- For 1 EXO[®] FFM is 8.3 pounds (3.77 Kg);
- For 2 EXO[®] FFM is 18.3 pounds (9 Kg);

The package dimension are:

- For 1 EXO[®] FFM is 12 × 10 × 12 inches (305 × 254 × 305 mm);
- For 2 EXO[®] FFM is 26 × 13 × 13 inches (660 × 330 × 330 mm);
- The EXO[®] FFMs are sent to dealers by plane and truck. Depending on how the dealer wants it sent.

9.1.1 One EXO[®] Full Face Masks



Packaging Step 1



Packaging Step 2



Packaging Step 3

9.1.2 Two EXO® Full Face Masks



Packaging Step 4



Packaging Step 1



Packaging Step 2



Packaging Step 5



Packaging Step 3

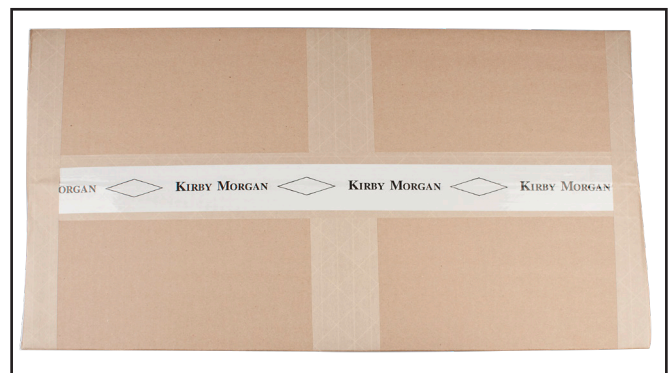

Packaging Step 4

9.2 Use of Kirby Morgan Original Replacement Parts

Users of Kirby Morgan life support equipment are cautioned to always use Kirby Morgan original replacement parts. Parts manufactured by third party companies can cause accidents.



*Look for the Kirby Morgan logo on Kirby Morgan products.
This is your assurance that you are getting genuine Kirby
Morgan replacement parts.*

Table of Equivalents

To convert units appearing in Column 1 (left column) into equivalent values in Column 2 (center column), multiply by factor in Column 3. Example: To convert 7 gallons into cubic inches, multiply $7 \times 231 = 1617$. To convert units appearing in Column 2 (center) into equivalent values of units in Column 1 (left), divide by factor in Column 3. Example: To convert 25 horsepower into Btu per minute, divide 25 by $0.02356 = 1061$

To Convert Into	Into To Convert	Multiply By Divide By
Atmospheres	Feet of Water	33.9
Atmospheres	Inches of Mercury (Hg)	29.92
Atmospheres	PSI (LBS per Sq. Inch)	14.7
BTU	Foot Pounds	778.3
BTU per hour	Watts	0.2931
BTU per minute	HorsePower	0.02356
Celsius (Centigrade)	Fahrenheit	$^{\circ}\text{C} \times 1.8 + 32$
Centimeters	Inches	0.3937
Cubic Centimeters	Gallons (U.S. Liquid)	0.0002642
Cubic Centimeters	Liters	0.0001
Cubic Feet	Cubic Inches	1728
Cubic Feet	Gallons (U.S. Liquid)	7.48052
Cubic Inches	Cubic Feet	0.0005787
Cubic Inches	Gallons (U.S. Liquid)	0.004329
Days	Seconds	86,400
Degrees (Angle)	Radians	0.01745
Feet	Meters	0.3048
Feet	Miles	0.0001894
Feet of Water	Atmospheres	0.0295
Feet of Water	Inches of Mercury (Hg)	0.8826
Feet of Water	PSI (Lbs per Sq. Inch)	0.4335
Feet per Minute	Miles per Hour	0.01136
Feet per Second	Miles per Hour	0.6818
Foot-Pounds	BTU	0.001286
Foot-Pounds per Minute	Horsepower	0.0000303
Foot-Pounds per Second	Horsepower	0.001818
Gallons (U.S. Liquid)	Cubic Feet	0.1337
Gallons (U.S. Liquid)	Cubic Inches	231
Gallons of Water	Pounds of Water	8.3453
Horsepower	BTU per Minute	42.44
Horsepower	Foot-Pound per Minute	33,000
Horsepower	Foot Pounds per Second	550
Horsepower	Watts	745.7
Hours	Days	0.04167
Hours	Weeks	0.005952
Inches	Centimeters	2.54
Inches of Mercury (Hg)	Atmospheres	0.03342
Inches of Mercury (Hg)	Feet of Water	1.133
Inches of Mercury (Hg)	PSI (Lbs. per Sq. Inch)	0.4912
Inches of Water	PSI (Lbs. per Sq. Inch)	0.03613
Liters	Cubic Centimeters	1000
Liters	Gallons (U.S. Liquid)	0.2642
Micron	Inches	0.00004
Miles (Statute)	Feet	5280
Miles per hour (MPH)	Feet per Minute	88
Miles per hour	Feet per Second	1.467
Ounces (Weight)	Pounds	0.0625
Ounces (Liquid)	Cubic Inches	1.805
Pints (Liquid)	Quarts (Liquid)	0.5
Pounds	Grains	7000
Pounds	Grams	453.59
Pounds	Ounces	16
PSI (Pounds per Sq. Inch)	Atmospheres	0.06804
PSI (Pounds per Sq. Inch)	Feet of Water	2.307
PSI (Pounds per Sq. Inch)	Inches of Mercury (Hg)	2.036
Quarts	Gallons	0.25
Square Feet	Square Inches	144
Temperature ($^{\circ}\text{F} - 32$)	Temperature ($^{\circ}\text{C}$)	0.5555
Tons (U.S.)	Pounds	2000
Watts	Horsepower	0.001341

